



# INTERPUMP

FLUID SOLUTIONS 

Powered by I.M.M. Hydraulics

Technical Data  
General sales terms  
and conditions

2022



# **INTERPUMP**

**FLUID SOLUTIONS** 

Powered by I.M.M. Hydraulics

**THE STRENGTH OF A BIG GROUP  
GUARANTEE OF HIGH QUALITY**



## **Index**

Worldwide connection .....	4
The structure and production plants of I.M.M. Hydraulics .....	5
I.M.M. Hydraulics production .....	6
The strengths of I.M.M. ....	7
Technical aspects in evidence.....	8
Certification and I.M.M. Market .....	10
Our quality: extreme reliability.....	11
Piece by piece, step by step.....	17
Safety indicators, attention and notes .....	20
Safety warnings .....	21
Hose assembly selection.....	22
Hose size and flow rate .....	24
Pressure .....	26
Further advices .....	27
Hose assembly preparation .....	29
Testing and inspection .....	36
Cleaning hose .....	36
Handling and storing .....	37
Preventive maintenance-according SAE J1273 .....	38
Guidance safety-SAE J1273 .....	40
IMM cover solutions.....	48
Technical reference tables.....	49
General sales terms and conditions.....	57

## WORLDWIDE CONNECTION

Interpump Fluid Solutions (powered by IMM Hydraulics Spa) is an important part of the Interpump Group. We provide our customers across the world with a complete package of hydraulic hoses, fittings, machines and accessories.

We provide solutions for a wide range of applications and sectors.

Interpump Fluid Solutions is an important link between the hydraulic power generators and the actuators inside the Interpump Group.



## THE STRUCTURE AND PRODUCTION PLANTS OF I.M.M. HYDRAULICS

I.M.M. Hydraulics S.p.A. is a world leader and acknowledged innovator in the production of hose and fittings for hydraulic systems.

The company supplies the most prestigious OEMs in the world and its products are used in many sectors such as agriculture, marine, offshore, construction, lifting equipment, energy, military movement, cleaning, rail.

We provide international sales and service from our manufacturing facilities in 5 countries, 10 production and commercial sites, and the collaboration of 800 members of staff.

10% of our team are engineers and product specialists working in research and development. We are driven and inspired by innovation and we are fully continuous improvement oriented.

I.M.M. Hydraulics SpA owns the trademarks: Interpump Fluid Solutions, Hypress and Hydralok.

**Thirty five years of productions has made us the ideal partner for your hydraulic fluid solutions.**



**Growing  
turnover**



**35 years  
of know how**



**80.000 sqm  
of facilities**



**Staff  
of 800 people**



**Worldwide  
connection**

## **I.M.M. HYDRAULICS PRODUCTION**

I.M.M. Hydraulics SpA is a multinational company that designs, produces and distributes hydraulic hoses, hose fittings and adaptors, as well as related assemblies and machines to assemble.

The know-how acquired in 35 years of experience and continuous study of technological innovation for the implementation of new solutions, allows I.M.M. to position themselves as one of the most influential international benchmarks in the production of fluid connection systems.

The high technological standards, the substantial investments in process and material quality allow us to grow our core competencies. As a market leader, we produce 70 million items and 35 million of metres a year and achieve a consolidated turnover in excess of 120 million Euros.

Our manufacturing plants cover more than 80,000 square metres with over 500 machines and assembly systems.

## THE STRENGTHS OF I.M.M.

Our core strengths include:

- Certified and proven quality in the field;
- Extreme reliability;
- Flexibility and continuous improvement;
- Innovation;
- Product integration for comprehensive solutions.

IMM is highly flexible and provides solutions in line with market demands that meet ISO, SAE, EN, JIS construction standards, as appropriate. We exceed International standards with high performance and customer-focused solutions.

Our dedicated new product development focus, not only satisfies but exceeds customer needs.

"MARKET-IN" base approach is an I.M.M. unique ability in order to focus all efforts in the most important aspect of every business: the CUSTOMER.

Dedicated products development (or a combination of products is an aspect that makes the difference between IMM and others companies in "SATISFYING NECESSITY", which springs from a NEED. The study and the development of customer-specific solutions is therefore a absolute value added result for IMM.

## EVIDENCE OF TECHNICAL SPECIFICATIONS

### Fitting Solutions:

I.M.M. supplies fittings in both two-piece solution and ONE PIECE solution, highlighting the absolute ability to meet the demands of different markets globally.

I.M.M. fittings can also be supplied in the INOX version as a proof of the ability to provides high value added solutions for the most demanding applications.

### Surface Treatments on Fittings:

IMM is owner of the plant for the surface treatments pure Zn as well Zn-Ni.

This choose to ensure the high level of performance and reliability requested by the market.



**Our eco-friendly plant follows the most strictly requirements in terms of environment and safety.**

**The CrVI free passivation ensure a ENVIRONMENTAL FRIENDLY process.**

**A specific sealer is used to increase the performances of the products and to keep the friction coefficient under control.**

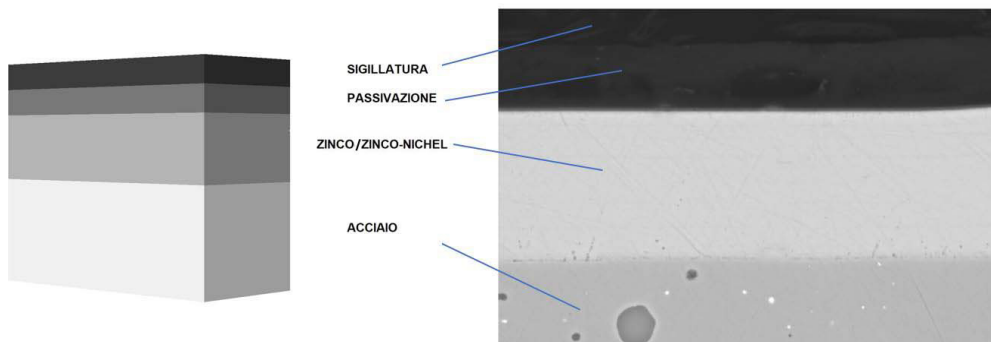



The available solution are able to ensure high reliability even in severe conditions:

Pure Zn treatment according to the **ISO 2081 Fe/Zn8/C/T2**

The pure Zn treatment, with minimum thickness of the Zn layer of 8µm and wite passivation, ansure a resistance to the red rust higher than the standard of the market. The color is matte metallic.

FINISHING	THICKNESS	MINIMUM RESISTANCE RED RUST
Pure zinc-plating, passivated CrVI free, with sealer.	>8µm	>400 h



Samples after 400h tested according to ISO 9227 NSS

Zn-Ni treatment according to **ISO 19598 Fe//ZnNi8//An//T2**

The Zn-Ni treatment, with a minimum thickness of a Zn-Ni alloy of 8µm (content of Ni of 12%-16%), has a gray-blue color with slight iridescence. The Zn-Ni treatment is suggested when a high corrosion resistant in agressive envinromental is required.

FINISHING	THICKNESS	MINIMUM RESISTANCE RED RUST
Gray-blue Zn-Ni plating, passivated CrVI free with sealer	>8µm	>720 h



Samples after 720h tested according to ISO 9227 NSS

### Product Qualification:

All our products are qualified in accordance with the related construction standards and technical specifications. All required tests are performed in our test laboratory with the latest generation machines. In ongoing collaboration with the market, we provide dedicated testing solutions for all projects developed for our customers.



### CERTIFICATION AND I.M.M. MARKET

Along with certified Environment, Quality and Safety Management Systems, we also focus on Type Ap-provals, for example, Certification of International Organisations for Specific Products. This allows us to provide strategic and highly selective specialisation in markets such as Mining, Naval, Offshore and Automotive. We understand market dynamics and needs through our strong, specialised and reliable team with wide-reaching distribution channels. We supply products and service to all industries requiring fluid line components and hose fittings, through our widespread network of centres across the world.

- Direct retail sales
- Express delivery
- Sales and after sales assistance
- Hose fittings centre
- Test and reporting services



# your hydraulic partner

Safety, Reliability and High Performance Level are recognized by Certifying Body such as DNV-GL, Bureau Veritas, Lloyd's register, RINA, Korean Register and Nippon Register that have released the related Approvals and Product Certification after dedicated audit and successfully witnessed tests.

I.M.M. Hydraulics is member of UNI (Italian Standardization Body) and ASSOFLUID (Italian Association of Hydraulics and Pneumatics Operators and Manufacturers).

This is a consistent Value Added in order to be always updated and informed about standards, applications and solutions.

Management System		Certifying Body
Quality	ISO 9001:2015	DNV-GL
Environment	ISO 14001:2015	DNV-GL
Health and Safety	BS OHSAS 18001:2007	DNV-GL

Type Approvals	
DNV-GL	Hypress 4SP MSHA, HyGreen 4SH MSHA, HyGreen R13 MSHA, HyGreen R15 MSHA, MARATHON, MARATHON MSHA, Hypress R17 MSHA, Hypress 2SC MSHA, LONGLIFE 2SC.
ABS	Hypress 1SC, Hypress 2SC MSHA, Hypress R17 MSHA, HyGreen 4SH MSHA, HyGreen R13 MSHA, HyGreen R15 MSHA, LONGLIFE 2SC, MARATHON 2SC MSHA.
LLOYD's Register	Hypress 2SC MSHA, Hypress R17 MSHA, Hypress 4SP MSHA, HyGreen 4SH MSHA, HyGreen R13 MSHA, HyGreen R15 MSHA, LONGLIFE 2SC, MARATHON 2SC MSHA.
RINA	LONGLIFE 2SC
Bureau Veritas	Hypress 2SC MSHA, Hypress 4SP MSHA, Hypress R17 MSHA, HyGreen 4SH MSHA, HyGreen R13 MSHA, HyGreen R15 MSHA, LONGLIFE 1SC, LONGLIFE 2SC, MARATHON 2SC MSHA.
KR	Hypress 2SC MSHA, Hypress 4SP MSHA, Hypress R17 MSHA, HyGreen 4SH MSHA, HyGreen R13 MSHA, HyGreen R15 MSHA, LONGLIFE 1SC, LONGLIFE 2SC, MARATHON 2SC MSHA.
NKK	Hypress 2SC MSHA, Hypress 4SP MSHA, Hypress R17 MSHA, HyGreen 4SH MSHA, HyGreen R13 MSHA, HyGreen R15 MSHA, LONGLIFE 1SC, LONGLIFE 2SC, MARATHON 2SC MSHA.
CCS	Hypress 1SC, Hypress 2SC MSHA, Hypress R17 MSHA, Hypress 4SP MSHA, HyGreen 4SH MSHA, HyGreen R13 MSHA, HyGreen R15 MSHA, LONGLIFE 1SC, LONGLIFE 2SC, MARATHON 2SC MSHA

Special Certification	
MSHA	Cover Compound
LAPI – EN 45545-2	Hose HyRail

Marine Equipment Directive	
MED-D	Hypress 2SC MSHA, Hypress 4SP MSHA, Hypress R17 MSHA, HyGreen 4SH MSHA, HyGreen R13 MSHA, HyGreen R15 MSHA, MARATHON 2SC MSHA.

## Regulatory Compliance

- RoHS
- REACH

## Collaborations/Associations

- ASSOFLUID
- UNI



# IMM quality certificate & assurance



HOSE CERTIFICATION CHART											
HOSE REFERENCE		TYPE APPROVAL							Specific Qualification & Certification		
Hose	Code	DNV-GL	ABS	LLOYD'S REGISTER	CCS	BV	KR	NKK	RINA	MED	Railway EN45545-2
Hypress 1SC	TFE201K		X								
Hypress 2SC	TFEM02K	X	X	X	X	X	X	X		X	
Hypress 4SP	TFDM4SP	X		X	X	X	X	X		X	
Hypress R17	TFSM017	X	X	X	X	X	X	X		X	
HyGreen 4SH	TFDR4SH	X	X	X	X	X	X			X	
HyGreen R13	TFDR013	X	X	X	X	X	X			X	
HyGreen R15	TFDR015	X	X	X	X	X	X			X	
LongLife 1SC	THE201K				X	X	X				
LongLife 2SC	THE202K	X	X	X	X	X	X	X	X		
Marathon	THEYM2K	X	X	X	X	X	X	X		X	
HyRail	TFDE011										X

## INTERPUMP HySO-FLEX 6K WS

TIS0042



### APPLICATIONS



### TYPE APPROVAL :

MED, DNV - GL, ABS, LR, CCS, BV, KR.

### APPLICABLE SPECS. :

EXCEEDS ISO 18752/CC

High Flexibility and Half Bend Radius. Qualification according ISO 18752/CC.

**Internal tube:** Synthetic rubber, extruded whole without joints, of uniform thickness.

**Reinforcement:** 4-6 High tensile steel spirals (4 spirals up to 1", 6 spirals from 1 1/4")

**Coverage:** Anti-abrasive synthetic rubber, resistant to oils, fuels and atmospheric conditions.

**Recommended fluids:** Mineral and biological oils, water, water based fluid, lubricants.

**Operating temperature:** from -40 to +120°C from -40 to +70° C for water based fluids, from 0 to +70°C water.

Part number	ID		Dimen- sions Dash size	OD	Max WP		Min BP		Min BR		Weight		One piece Fitting series	Ferrule	
	in	mm			bar	psi	bar	psi	mm	inch	kg/m	lb/ft		TWO PIECES NO SKIVE	TWO PIECES SKIVE
THE002K-06	3/8"	9.5	06	19.7	420	6090	1680	24360	65	2.559	0.662	0.445	N series	001C-06	05I4-06
THE002K-08	1/2"	12.7	08	22.5	420	6090	1680	24360	90	3.543	0.772	0.518	N series	001C-08	05I4-08
THE002K-10	5/8"	15.9	10	26.2	420	6090	1680	24360	100	3.937	0.938	0.630	N series	001C-10	
THE002K-12	3/4"	19.0	12	30.6	420	6090	1680	24360	120	4.724	1.388	0.933	N series	001C-12	004N-12
THE002K-16	1"	25.4	16	37.6	420	6090	1680	24360	150	5.906	1.940	1.303	N series	001C-16	004N-16
THE002K-20	1.1/4"	31.8	20	47.8	420	6090	1680	24360	210	8.268	3.455	2.322	N series	001C-20	0042-20

Available also with MSHA cover. In case of order use code TISM042.

8 Note:

MARKING: Available also embossed brand version. In case of order use TFW0085N.

**ih INTERPUMP** HySO-FLEX → 6K WS ISO 18752/CC - DN 12 I.D. 1/2" - W.P. 42,0 MPa/6000 psi - MADE IN ITALY

9

1	Type description	5	Applications	9	Marking	13	Min. bursting pressure
2	Features e Recommendations	6	Type Approval	10	Internal diameter	14	Min. banding radius
3	Product code	7	Order code	11	External diameter	15	Hose weight per meter
4	Applicable Specs.	8	Note	12	Working pressure	16	Raccanned fitting/ ferrule

1

BSP Female 60° cone Thrust Wire

3

0050

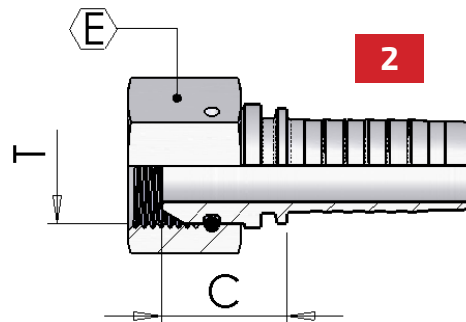

4

Part number	5 Hose I.D.		6 Dimension			
	in	mm	dash size	threadT	hex E	cut-off C
0050-03-02	3/16	4.8	03	1/8-28	14	15
0050-03-04	3/16	4.8	03	1/4-19	19	17
0050-04-02	1/4	6.4	04	1/8-28	14	15
0050-04-04	1/4	6.4	04	1/4-19	19	17
0050-04-06	1/4	6.4	04	3/8-19	22	19
0050-04-08	1/4	6.4	04	1/2-14	27	22
0050-05-04	5/16	7.9	05	1/4-19	19	17
0050-05-06	5/16	7.9	05	3/8-19	22	19
0050-05-08	5/16	7.9	05	1/2-14	27	22
0050-06-04	3/8	9.5	06	1/4-19	19	17
0050-06-06	3/8	9.5	06	3/8-19	22	19
0050-06-08	3/8	9.5	06	1/2-14	27	22
0050-08-06	1/2	12.7	08	3/8-19	22	20
0050-08-08	1/2	12.7	08	1/2-14	27	23
0050-08-10	1/2	12.7	08	5/8-14	30	20
0050-08-12	1/2	12.7	08	3/4-14	32	27
0050-10-08	5/8	15.9	10	1/2-14	27	23
0050-10-10	5/8	15.9	10	5/8-14	30	20
0050-10-12	5/8	15.9	10	3/4-14	32	25
0050-12-08	3/4	19	12	1/2-14	27	24
0050-12-12	3/4	19	12	3/4-14	32	25
0050-12-16	3/4	19	12	1-11	38	26
0050-16-12	1	25.4	16	3/4-14	32	27
0050-16-16	1	25.4	16	1-11	38	27
0050-16-20	1	25.4	16	1.1/4-11	50	30
0050-20-20	1.1/4	31.8	20	1.1/4-11	50	32
0050-20-24	1.1/4	31.8	20	1.1/2-11	55	34
0050-24-24	1.1/2	38.1	24	1.1/2-11	55	34
0050-24-32	1.1/2	38.1	24	2-11	70	34

7



O-Ring

1

Type description

4

Order code

7

Note

2

Description

5

Inte. hose diameter

3

Product code

6

Main dimension



**Agriculture**



**Cranes/Lifting**

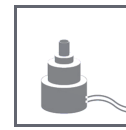

**Hydraulic rams**



**Lifts**

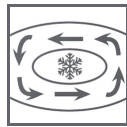

**Air Conditioning/  
Refrigeration Systems**

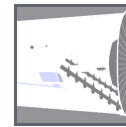

**Mining & Drilling**



**Test Benches**

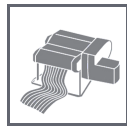

**Food Industry**



**Ground movement**



**Chemistry**

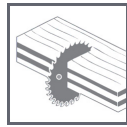

**Wood Industry**



**Biological Oil**



**Compressors**



**Railway**



**Entertainment**



**Oil-Gas**



**Industry**



**Jet Grouting**



**Elevators**



**Cleaning**



**Swaging Machines**



**Energy**



**Automatic Machines**



**Hydraulic tools**



**Foundry-Steel Industry**



**Marine/Off Shore**



**Vehicles**



**Sewer system**



**Truck**



**Lift truck**

System subject to normal temperatures



System subject to low temperatures



System subject to high temperatures



# Technical Info



## Piece by piece, step by step.

I.M.M. Hydraulics fittings are made of carbon steel (11SMnPb37) or stainless steel AISI 316L controlled and certified.

At the end of their production process, carbon steel fittings undergo an iridescent trivalent zinc plating (minimum thickness 8 microns).

To order hose fitting and/or adaptor in stainless steel material, it's sufficient to insert letter "X" before standard code

### EXAMPLE CODE FOR CREATING ORDER

Type		Hose Dash Size		Thread Dash Size	Note	Part Number
0051	-	06	-	08	Standard	<b>0051-06-08</b>
0051	-	06	-	08	No Skive HySO-FLEX hose	<b>0051N06-08</b>
0050	H	20	-	24	Inter-Lock	<b>0050H20-24</b>
0051	G	06	-	08	One Piece Wired Hoses	<b>0051G06-08</b>
0050	N	16	Q	20	One Piece 4 Spiral HySO-FLEX Hoses	<b>0050N16Q20</b>
0050	N	20	S	24	One Piece 6 Spiral HySO-FLEX Hoses	<b>0050N20S24</b>
0051	X	32		32	One Piece SAE/EN Spiral Hoses	<b>0051X32-32</b>
0051	W	06	-	08	Waterblast*	<b>0051Y06-08</b>
0051	Y	06	-	08	Multispiral	<b>0048M08-24</b>
X0051	-	06	-	08	Stainless Steel / Inox	<b>X0051-06-08</b>

Note: in case of order of the Zn-Ni add the suffix "NI" to the standard code, e.g. 0051N06-08NI

### Sealing features:

- sealing thread: in this case the sealing is assured by the flattening of the thread edges when you screw male on the female.
- with O-ring: this kind of connection, suitable for high pressure applications, is guaranteed by the compression of the seal into the corresponding component.
- metal to metal: the two angled faces are wedged into one another by the tightening of the threaded nut and allow the sealing.
- angle combined with O-ring: the seal is situated on the angled face of the fitting sealing and it is deformed simultaneously with the wedging of the angled faces.

On the following page are the main connection types with corresponding standards.

The choice of the correct connection type depends on several aspects such as combination type, working pressure, temperatures, chemical compatibility, corrosion resistance, vibrations presence, etc.

**Metric Connections (1)**

Known as DIN or metric fittings, they guarantee the sealing thanks to sealing angled faces (metal to metal) or to the combination of metal to metal with O-ring seal. The angles of the sealing face are 24° with or without seal.

**60° conical connections (2)**

Known as BSP connections (British Standard Pipe) even known as "Whitworth thread" which can be parallel (BSPP) and conical (BSPT). The sealing is assured by angled metal faces, with or without Oring, with a 60° angle for both shapes.

**BSPT Connections (3)**

The sealing is guaranteed by the sealing thread. Since the sealing depends just on the threads deformation, it's suggested the use of a sealing material. The difference of the NPT conical connection is on the thread shape which has a 55° angle.

**Cone 37° - SAE J514 (4)**

Known as JIC fittings, they guarantee the sealing through combination metal to metal with a 37° flare sealing surface without the deformation of the single component. The threads are UNF upright.

**Flat sealing with O-ring – SAE J1435 (5)**

This kind of combination guarantees the best sealing with high pressures. The sealing is assured by the o-ring compression present on the male on the flat face of the female. The thread mechanically allows the combination.

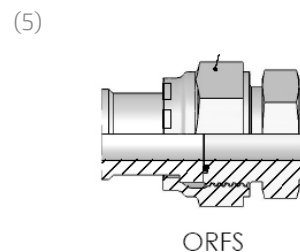
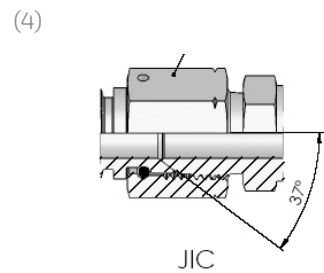
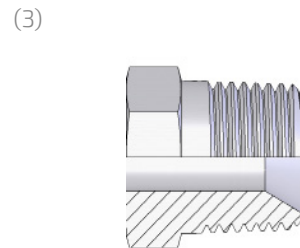
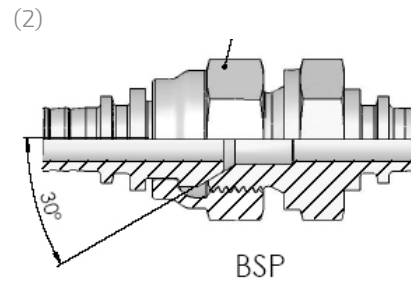
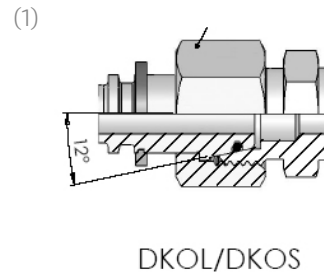

**SAE with O-ring – SAE J516 type BOSS**

Male fitting equipped with UNF upright threads, a flat sealing surface and a O-ring. The sealing is assured by the O-ring seal of the male and the sealing surface of the female.

It's compatible just with fittings type BOSS: SAE J1926.

**NPTF/NPSM - SAE J516**

The sealing is guaranteed by the sealing cone thread. The sealing faces are 30° angled, the thread has an angle of 60° different than BSPT connection.

**24° Gas cone - French series**

They are equipped with a 24° seal support face with upright metric threads. Similar to DIN fittings, they have a thinner thread.

**JIS (Japanese Industrial Standard)**

The metal to metal sealing system through 30° conical faces. They can be divided into:

- JIS Toyota: with cone on the female inverted than the BSP connections, thread BSPP;
- JIS Komatsu: as Toyota connections but with metric thread;
- JIS Nissan: completely similar to BSP connections, except some differences on the cone dimensions.

## Safety Indicators, Attention and Notes

In this section are showed important safety indicators. They have been used three categories of indicators, listed in a decreasing order of importance.



**WARNING:** It is used in order to evidence potentially dangerous situations and/or procedures for health or life of the operator.



**ATTENTION:** It is used in order to evidence situations and/or procedures that can damage the functionality of the product.



**NOTE:** It is used in order to evidence important informations or callbacks to International Standards.

Purpose of the present handbook is to supply useful indications and advice for the correct choice, installation and maintenance of the assembly, in order to assure long life in service.

## Safety warnings



**WARNING:** It could be dangerous for the safety and the health of the persons:

- an improper choice of the product;
- not corrected assembly or installation;
- the damaging of the hoses.

An opportune training, of which this handbook wants to be one of the instruments for the operators, the staff of the maintenance and persons who work with assembled hoses, is fundamental in order to avert eventual dangers.

The SAE J1273 or ISO / TR 17165-2 " Practical recommendations to use assembled hoses", to which this handbook makes reference, supplies profits indications in merit, in particular paragraph 4 lists some risks upgrade linked to hydraulic systems and connection under pressure.

## Hose assembly selection



**REMINDER:** SAE J1273 clearly states that "...fittings of a producer are not generally compatible with hose supplied from another producer"

Normative reference: ISO 17165-2, SAE J1273, EN 982.

"Assembled hose" is defined the whole set of hydraulic hose with the fittings and the connectors.

The characteristics of an assembly have to be:

- Flexibility: resistance to bending and torsion stress of the mechanical machines;
- Stability: for a corrected power transmission and flow control a lowest volumetric expansion/process foaming is necessary;
- Minimal flow resistance: the choice of correcting assembled (hoses and fittings) and the lay out must guarantee the maximum efficiency of the hydraulic circuit.



**WARNING:** The hydraulic fluid under pressure is dangerous and it can cause serious lesions and risks for the person.

Follow an indication for the correct hose selection in few simple passages:

Application: it is necessary to define clearly:

- type of application required (high pressure line, suction line, pilot line...);
- where the hose will be installed (installation difficulty, heat source presence, external mechanical loads, delivery pump...);
- type of machinery (presence of pressure peaks , vibrations, flexibility etc...);
- special required performances (electric conductivity, abrasion resistance, flame-retardant etc...);
- required connections, screw thread;
- type of fluid and chemical compatibility;
- temperature and environmental conditions (salt water, presence of chemical agents, direct and extended exposure to the solar beams ...);
- eventual standard and/or local obligations.

Often for severe applications, the IMM High Performance line offers the best solution in order to guarantee a long life in service of the assembly. Generally they can be considered inside of a hydraulic circuit:

#### Pressure lines

- working pressure up to 420 bar and over;
- fluid high-speed until 8 m/s;
- several working conditions, with possible pressure peaks ( especially in delivery pump) and vibrations;
- generally medium high pressure hoses are required.

#### Return lines

- working pressure up to 50-70 bar;
- moderate fluid speed ~ 3,0-4,0 m/s.

#### Suction lines

- necessary characteristic is the loadless resistance;
- generally used hoses of great diameter to reduce the pressure drops;
- low pressure; max 10 bar;
- moderate speed to avoid cavitation ~ 1,5 m/s;
- required loadless resistance until to -0,8/-0,9 bar;
- optimum solution is the chafing strip with steel spiral (rif. SAE 100 R4).

#### Pilot lines

- mid pressure line until to 100 bar;
- fluid speed mid-high ~ 5 m/s;
- compactness and high flexibility are indispensables to installation.

The IMM Pilot line enclose all these particulars with an extremely light hose line and reduced bending radius.

## Hose size and flow rate

The dimension of components must be carried out to ensure a regular fluid flow rate, in order to reduce the number of pressure drop and to avoid excessive speed/turbulence of conveyed fluid. For the hose diameter selection it's possible to relate to nomogram attached in Appendix "A". It's enough to know the maximum speed to convey and the flow rate of fluid.

The maximum speed advised for the fluids depend on the application:

- suction lines: 0,5-1,5 m/s;
- return lines: 1,5-3,5 m/s;
- pressure lines: 3,0-8,0 m/s;
- pilot lines: ~5,0 m/s.

The diameter of hose to be considered is that which makes the measure of internal diameter of the flexible hose. There are different way to indicate the measure of internal diameter:

dash size	SAE Dimensions (Inch)	Diameter	EN DN
This is the I.D. in 1/16"			
-3	3/16	4,8	5
-8	1/2	12,7	12
-10	5/8	15,8	16



## Appendix "A"

### Recommended line speed:

Pressure lines: 3 - 8 m/s

Return line: 1,5 - 3 m/s

Suction lines: 0,5 - 1,5 m/s

Pilot lines: max 5 m/s

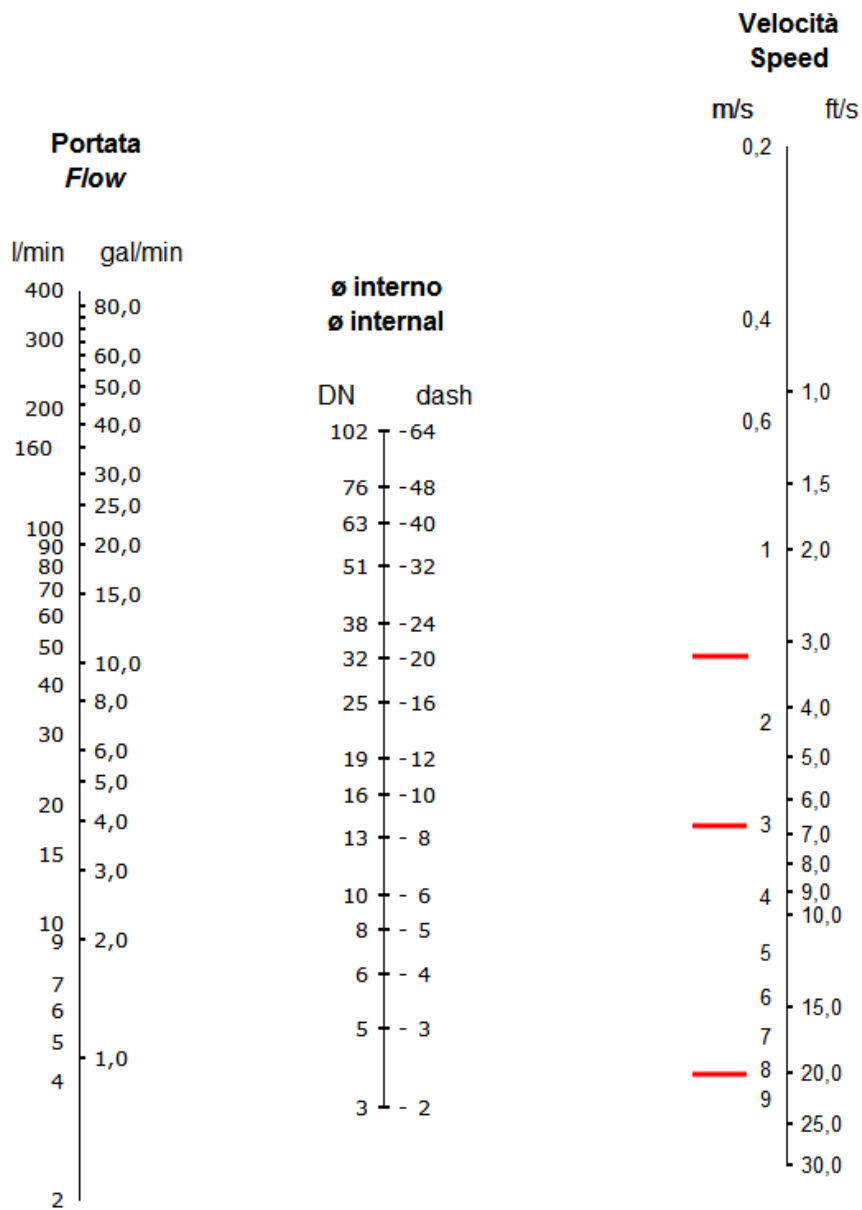

## Pressure

To properly select the flexible hose and the fitting consider that the maximum working pressure for these components must be equal or higher than the maximum system pressure.

It's necessary to consider both static working pressure and the so-called "pulsing" pressure when inside the system a pressure variation occurs with a not continuous attitude.

SAE J1927 Standard, gives a method to define life reduction of the flexible hose according to a specific hydraulic application, above all facing the pressure peaks and pulsing frequencies



**WARNING:** Selection has to be made according to the maximum pressure reached by the system.

Pressure surges and peaks verification can be made just through specific device able to record short surges. Anyway, a first choice can be calibrated checking the safety valve placed on the plant in order to be assured against eventual pressure surges and peaks.

Hydraulics system classification can be made according the following pressure range:

- low pressures: up to 70÷110 bars (1500 PSI);
- medium-high pressures: 210÷245 (3000 – 5000 PSI);
- high-very high pressures: up to 420 bars and over (6000 PSI)

## Fluid to convey

Fluid type: chemical identification, concentration, temperature, etc...

Flexible hose selection has to consider chemical compatibility of the conveyed fluid.

The enclosed summarizing sheet gives information about compound type used for the production of the flexible hose, in this way, it's possible to verify the compatibility of the product with different fluid types (sheet...). The sheet concerning chemical resistance informs about the compatibility with several products.

Be careful about those applications which need to use dangerous and aggressive fluids and/or are critical from the safety point of view

To evaluate the use of pin-pricking covering in case of permeability of the fluid through the hose.

## Temperature

The internal temperature of the conveying fluid must not at all overcome the advised temperature range stated on the product sheet.

Temperatures higher than the stated one, influence mechanical features of the rubber speeding up rubber ageing and compromising flexible hose life.

Temperatures lower than the suggested one can highly reduce the flexibility causing fragility of the rubber and possible cracks.

Generally, most of the compounds can work within a temperature range -40°C and +100°C with possible surges (peaks) up to 125°C.

The wide variety of variables in service can significantly alter the projected life.

Special rubber compounds allow to make the temperature break much more longer.



**ATTENTION:** Work continuously at temperatures close to the limits of specified operating, reduce the hose life (SAE J1273, DIN 20066 ....).

For extreme temperatures refer to T products lines "High/Low temperature".



**NOTE:** As clearly detailed in the following paragraphs, the temperature of the external environment greatly influences the assembled product life. Avoid to install the assembled product near heat sources or provide to properly screen it.

An increase of 10°C above the maximum temperature may decrease hose life by half. Cracks can also be caused by flexing, especially at excessively low temperature.

## Connection types

In order to get a long life of the assembly it's necessary to correctly select the connections to use. It's important to follow information contained inside this catalogue to choose the right connection.

For each hose is suggested the correct couplings (ferrule + insert) with corresponding swaging information. This combination is guaranteed by IMM thanks to several tests performed in laboratories specific through test benches. IMM does not guarantee any combinations between flexible hose and fittings which do not follow the suggested indication detailed in this catalogue and/or not supplied by IMM.

"SAE J1273 clearly states that components coming from two different manufacturers are not usually compatible each other."

Choosing the correct connections remember to verify:

- the sealing capability at the requested working pressure;
- the corrosion resistance;
- the presence of vibration (flanges and O-ring are suggested in case of high vibrations);
- in case of O'ring the working temperatures (a specific material can be necessary for the sealing o'ring);
- the resistance to the fluid and to the environmental conditions.

## Further advices

### External environment

Ozone, UV radiations, heat or chemical agents can cause damages to the flexible hose and fittings reducing their life. It is important to evaluate the characteristics of the external environment (in terms of temperature, ozone, chemical agents and/or solvents) in order to choose the proper external covering. Sometimes it's suggested to choose the special lines (Long life, MARATHON e.g.), which assure better performances with demanding using conditions.

For particular requirements such as fire resistance, conductivity, etc., where the information of the catalogue are not enough detailed to select the hose, address to IMM technical service to get the necessary support.

## Vibrations

Also vibrations can reduce the hose life.

Where it's necessary, make tests about hose vibrations to check amplitude and frequency.

In case, use collars or similar systems to reduce the effect.

## Hose assembly preparation

### Hose assembly length

Hose cut has to be performed correctly and with the proper device in order to have :

- square cutting surface, perpendicular to the hose axes;
- avoid to damage the reinforcement.



**ATTENTION:** Remember, a not squarely cut always causes:

- lack of sealing and assembly leaking;
- irregular rubber compression during the swaging and possible ferrule break.

As a suggestion, consider that for a spiral hose a lower cutting speed then braided hose is suggested (cutting blade rotation and cutting speed).

Hose assembly length has to be calculated according the following indication: (refers to SAE J 517 – 10):

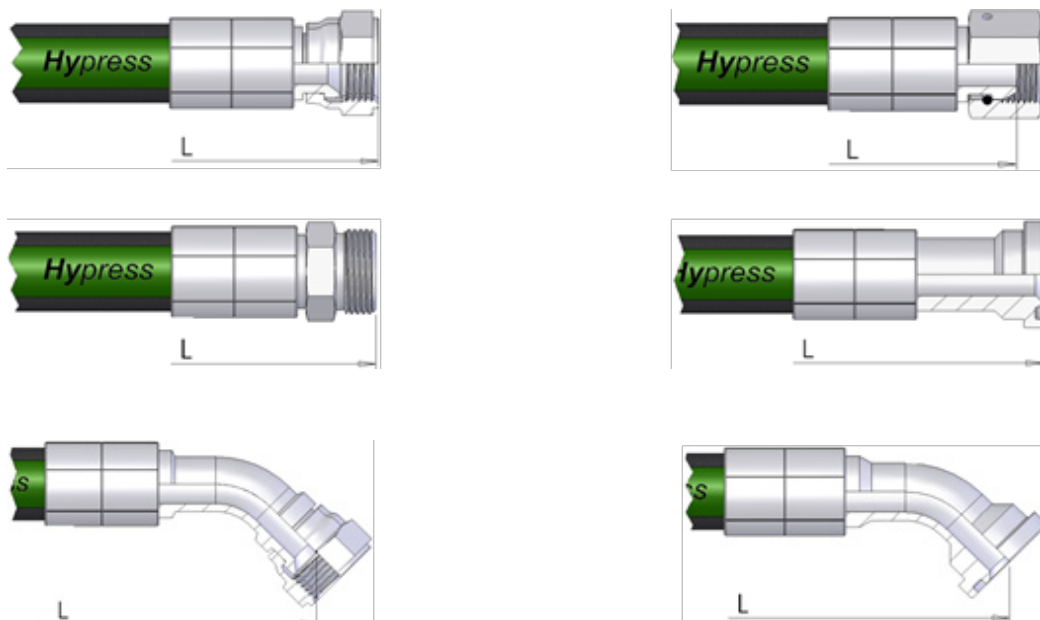

Several Standards (DIN 20066, EN 853 – 857, etc...) define the hose assembly length tolerances referring to the hose size and the total assembly length .

Following the indication inside DIN20066, EN 853, EN856, EN856 and equivalent ISO:

Lenght	up to DN25	from DN 32 to DN 50	from DN 60 to DN 100
up to 630 mm	+7 / -3	+12 / -4	+25 / -6
631-1250 mm	+12 / -4	+20 / -6	+25 / -6
1251-2500 mm	+20 / -6	+25 / -6	+25 / -6
2501-8000 mm	+1,5% / -0,5%		
more than 8000 mm	+3% / -1%		

Refer to the following picture to define the correct fitting orientation:

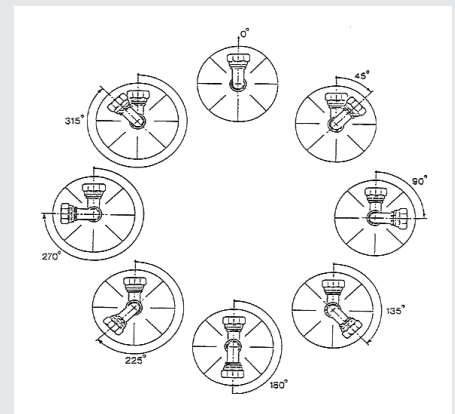

Keep straight the further end and rotate clockwise the closet end of the requested angle.



**NOTE:** Always consider the natural hose bend, in order to avoid mechanical stress on the hose.

## Routings

Follow some precaution mounting the hose assembly in order to avoid hose damage and compromise the sealing:

### 1-Hose assembly lenght

Provide the right lenght for the assembly. Over lenght will cause pressure loss. Short lenght could cause hose traction. Always consider some slack in the hose to allow shortening or elongation.

Hose lenght has to go along with the machine movement, in order to avoid kinks and stress.

Consider hose lenght variation and define the right lenght and the correct clamping position to fix the assembly.

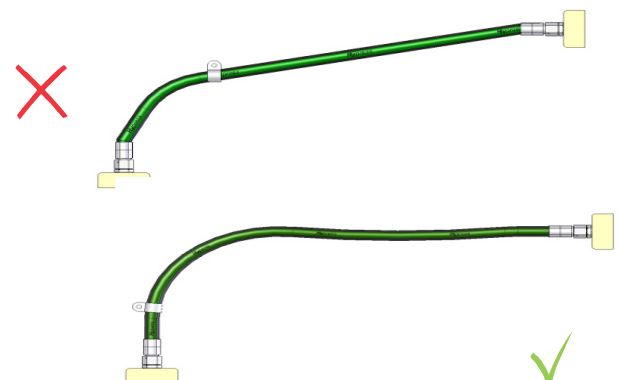
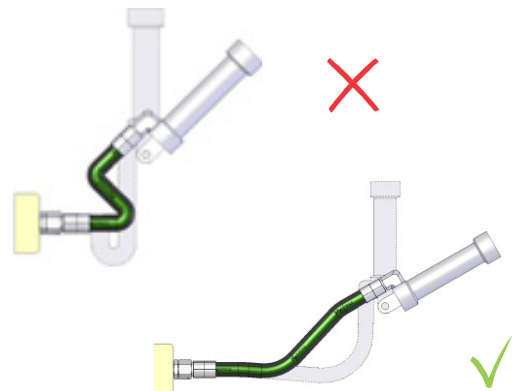
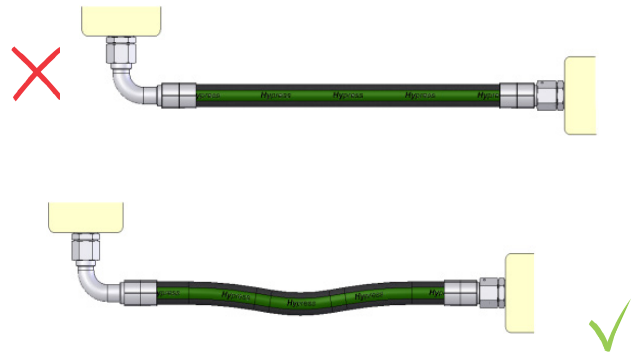

## 2-Minimum bend radiust

Always consider the recommended minimum bend radius and provide sufficient hose so that the hose is not pulled or stressed. Installation with a tighter bend will reduce hose life.

A minimum length of 1,5 times the external hose diameter is allowed (D) between hose fittings and the bend.

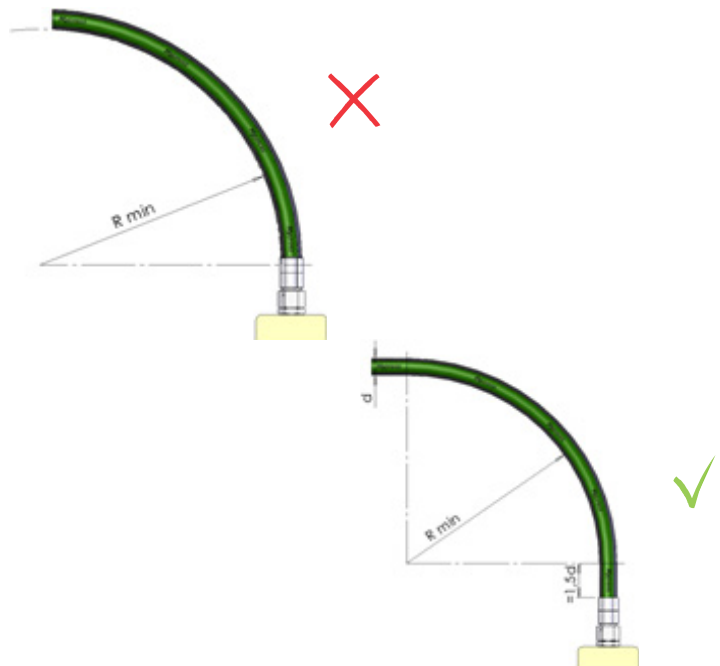

Use proper adapters and hose fitting termination, in order to avoid tight bend.

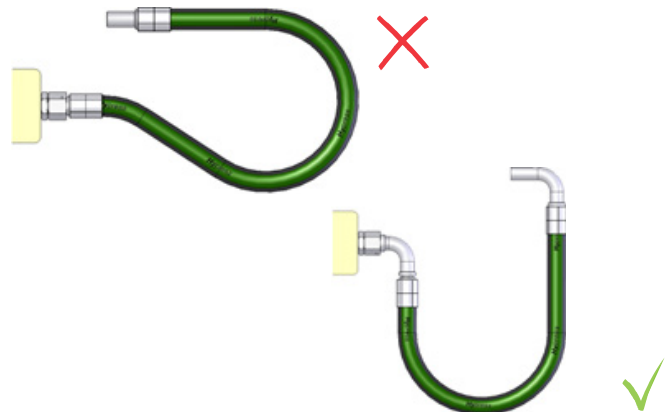

Too tight a bend may kink the hose, restrict or stop the fluid flow, or damage the hose reinforcement.

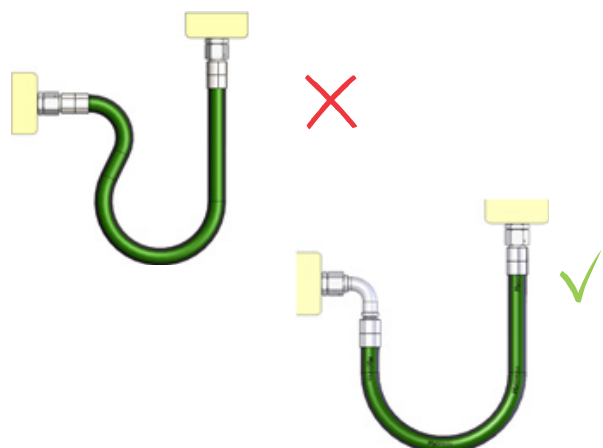



### 3–Hose protection

Protect hose against damage, abrasion and avoid contact with sharp and hard parts.

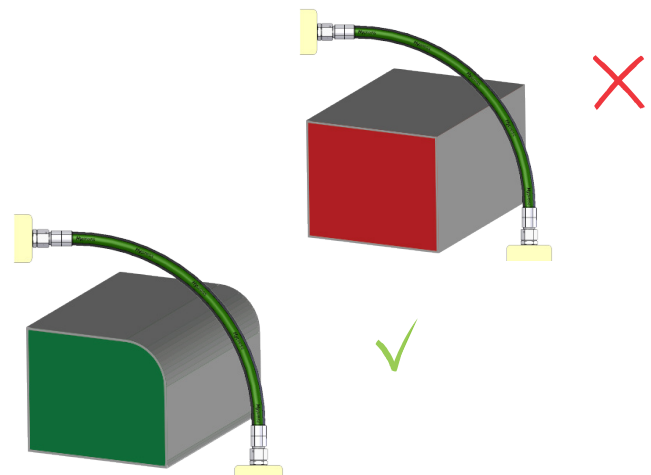

Isulate the hose assembly form heat source, using shield, fire sleeve, metal protection.

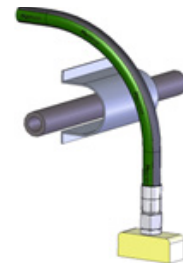

### 4–Hose movement

Take into consideration relative movement between the two connected part. Avoid hose torsion: during the application the hose has to flex in one single plane.

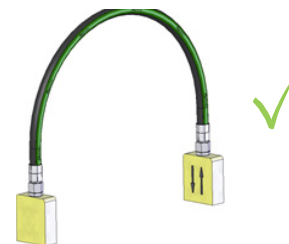
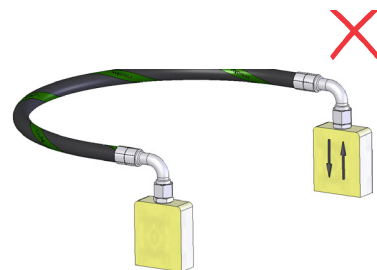

Do not install hose with a twist. Always consider the use of the right adaptor to avoid twist, swivel nut, swivel adaptors ...  
To avoid torsion, use the brand line as straight guide.

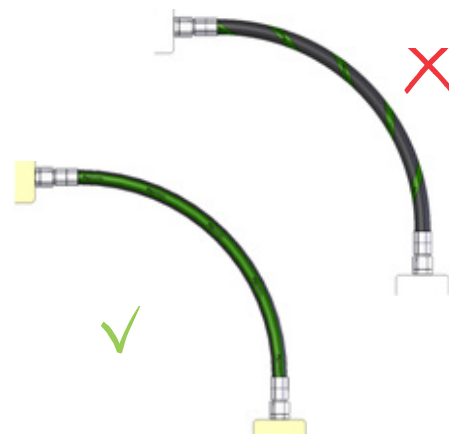

## 5-Routing

Whether the hose link two different planes, fix the assembly at change of plane, in order to allow flexion only in one plane.

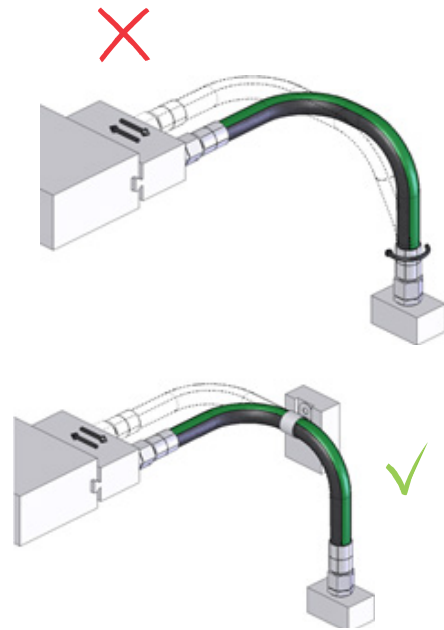

Always consider the use of 90° or 45° adaptors in order to have a better layout. The system will result easier to set up, easier to maintain, easier to check for leakage.

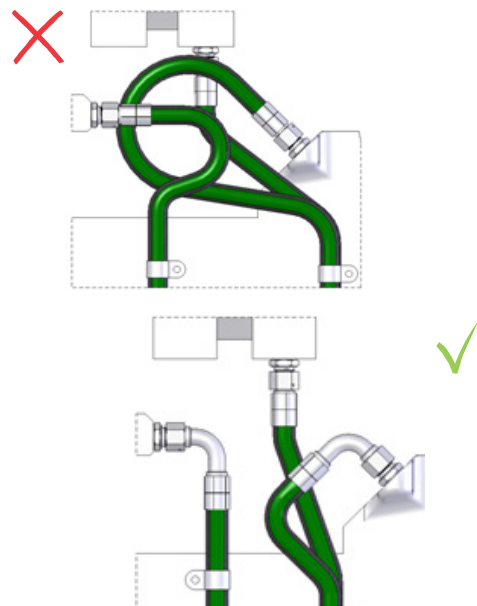

Always use clamps and wrapper to support long length assembly.  
Fix properly long length assemblies, with the suitable clamps in order to avoid hose whipping and to stress fittings end.

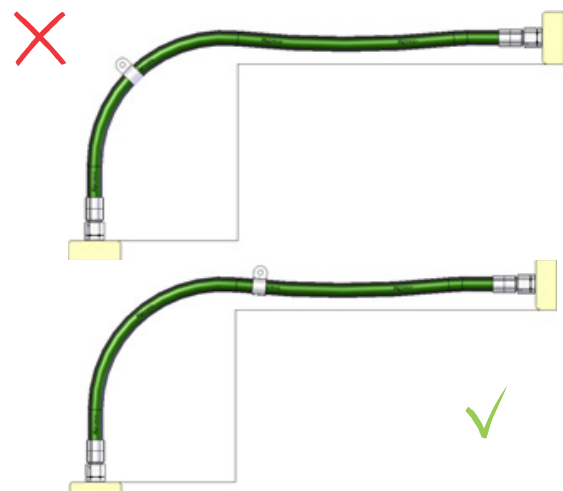

A misalignment between sealing cone and thread causes "leakage".



Above the mentioned warning, always remember during the tightening:

- fasten the end without tightening;
- rotate the hose according to the natural bend;
- tighten the end avoiding hose twisting ;
- mount the ends without damaging the thread (follow the suggested tightening torque to guarantee the damage of the thread);
- always verify that the surface is dry
- verify the cleanliness of the sealing surface;
- verify the presence of the O'ring where is requested.

## Testing and inspection

Make an inspection to verify cut, abrasion, worn on the hose.

Perform the requested test if necessary (Rif. ISO 1402).

Clean the assembly using "pig" and sponge or flushing the assembly to reach high cleaning level.

Once the installation is completed let the air come out, increase the pressure up to the working rate and verify the sealing of the assembly.

In order to avoid injury during the final test:

- do not touch any part of the system during the proof test;
- keep away from the risky area ;
- decrease the pressure till the system is discharged before tightening the connection.

## Cleaning hose

After assembling the hose and performed the necessary tests, remove all possible contamination.

Be sure that the cleaning level fit the application needs. Impurities and pollution could damage the system: impurities and pollution could damage the system:

- block hydraulic components reducing the efficiency;
- worn the tube causing a premature failure
- lower heat dissipation.

The assembly can be cleaned using special "PIG" (sponge projectiles) shoot by a compressed air circuit.

It is possible to use special machine to flush the assembly using water based fluid opportunely filtered.

It is possible, in this way, to gain high level of cleaning (refer to international Standard NAS 1638, ISO 4406, SAE479, B55540/4).



**NOTE:** All the assembly should be protected by means of proper cup to avoid pollution.

## Handling and storing

Rubber and plastic products can alter their characteristics during time. It is necessary to store hoses in order to control their ageing, implementing the FIFO (first-in, first-out), the manufacturing date of the hose and/or the assembly will give the priority.

Several Standard give useful indication on the storing:

ISO 2230 e ISO 8331, BS 5244, SAE J1273, DIN 7716, DIN 20066

## Maximum hose storage depends on several parameters:

### - Ambient – Temperature – Umidity

Goods has to be stored in dry and fresh area, without dust. Temperature generally between 5-25°C (do not exceed 38°C) and humidity around and not higher than 65%. Keep far from heat sources.

### - Sunlight and rain

Hose should be protected form sunlight and UV sources. It is generally suggested to paint warehouse.

### - Oxygen and Ozone

Hose should be protected form the circulating air and pace in closes box or by means of polyethylene envelope. High voltage electrical equipment should be avoided because of the harmful effect of ozone.

### - Oil, solvents, fumes ...

Avoid contact with corrosive agents, detergent, and other organic liquidas, Somemetals could also affect the rubber (manganese, iron, copper).

### - Narrow spaces and bending

The internal diameter of the coil/bobbin must be higher then double the minimum bending radius of the product (acoording the manufacturer indication).

Do not bend or pile the hose.

Avoid every mechanical stress (tension, compression) which can speed up the ageing.

### - Protect the hose form insects and rodent.



**NOTE:** Always check hoses integrity before deliver. It is recommended to perform further test on the hose in case of long lasting storing.

### Hose manufacturing date

### Assembling Hose

### Service life

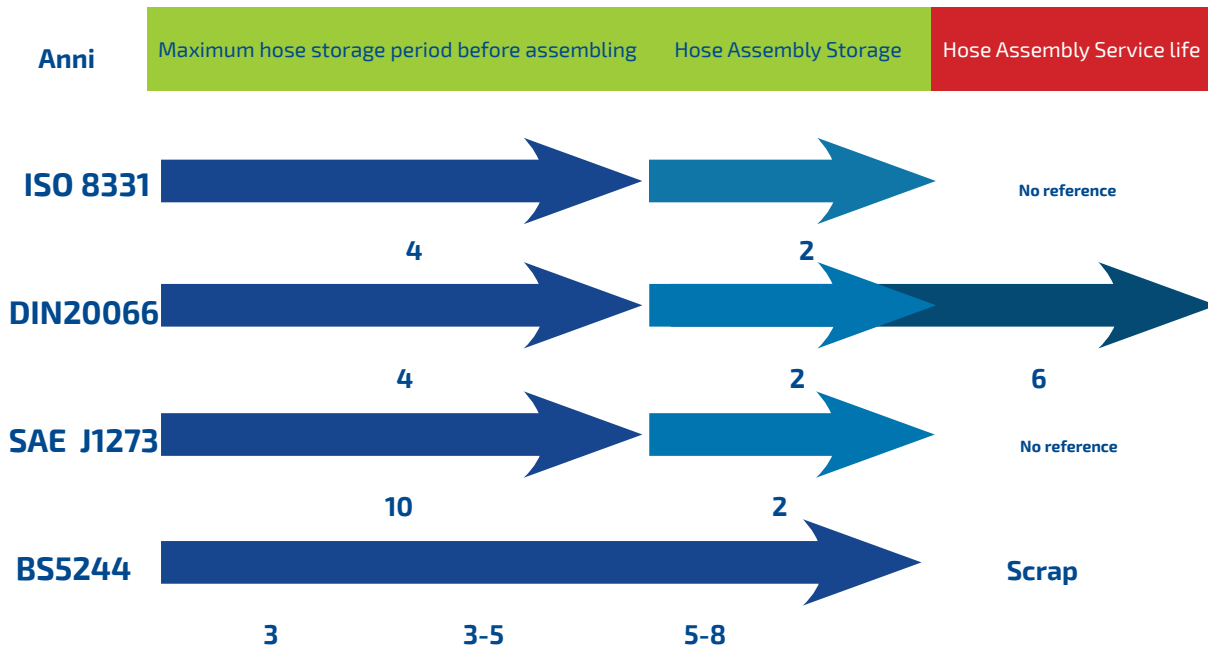

#### S 5244:

- within 3 years the use of the hose is permitted without further tests.
- from 3 to 5 years proof pressure test needed before to use hose
- from 5 to 8 years proof pressure, burst, impulse, cold flexibility and electrical tests needed before the use of the hose
- after 8 years the hose have to be scrapped

## Preventive maintenance - according SAE J1273

A good preventive maintenance program can highly guarantee a reliable equipment in service, avoid injury and keep the system at its maximum efficiency.

### Frequency of inspection

Environmental conditions can cause hose and fitting degradation. Conditions to evaluate include, but are not limited to:

- Ultraviolet light
- Salt water
- Air pollutants
- Temperature
- Ozone
- Chemicals
- Electricity
- Abrasion

If necessary, consult our Technical Department for more information

## Visual check (hose and fittings)

Visual inspect hose and fittings to evaluate:

- a. Leakage;
- b. Cover damage, cut or abrasion;
- c. Exposed Reinforcement;
- d. Hose dent, bent under the minimum allowed bending radius, or in torsion;
- e. Hose stiffend, or with hard/burnt cover;
- f. Cover spole, or with low adhesion;
- g. Fittings damaged or bad corroded;
- h. Fittings not properly tightened;
- i. Other possible non conformities.

Whenever, a non compliance has been detected, verify the assembly and eventually substitute it.

During hose and fittings inspection, verify all the hydraulics components on the system in order to check:

- a. Connection sealings;
- b. Damage of the assemblies due to missing of guide, clamps or guard;
- c. Excessive dirt and debris around hose;
- d. Fluid: level, type, clearing ed absence if air.
- e.

If any of these conditions exsist, solve the problem.

## Functional test

Functional test have to verify the correct system functioning.

Control the whole system behaviour under normal working pressure according the manufacturer indications.

## Guidance safety - SAE J1273



**WARNING:** Improper selection, fabrication, installation, or maintenance of hose and hose assemblies for fluid-power systems may result in serious personal injury or property damage. These recommended practices can reduce the likelihood of component or system failure, thereby reducing the risk of injury or damage. It is important to consider all the aspects related to the application and to respect the following technical indication and suggestion inside this manual.

Listed are some potential conditions and situations that may lead to personal injury and/or property damage:

### Fluid Injections

Fine streams of escaping pressurized fluid can penetrate skin and enter a human body.

These fluid injections may cause severe tissue damage and loss of limb. Consider various means to reduce the risk of fluid injections, particularly in areas normally occupied by operators.

Consider careful routing, adjacent components, warnings, guards, shields, and training programs. Relieve pressure before disconnecting hydraulic or other lines. Tighten all connections before applying pressure.

Avoid contact with escaping fluids. Treat all leaks as though pressurized and hot enough to burn skin. Never use any part of your body to check a hose for leaks.

If a fluid-injection accident occurs, see a doctor immediately.

Do not delay or treat as a simple cut! Any fluid injected into the skin must be surgically removed within a few hours or gangrene may result.

Doctors unfamiliar with this type of injury should consult a knowledgeable medical source.

### Whipping Hose

If a pressurized hose assembly blows apart, the fittings can be thrown off at high speed, and the loose hose can flail or whip with great force. This is particularly true in compressible-fluid systems. When this risk exists, consider guards and restraints to protect against injury.

### Fire and Explosions from conveyed fluids

Most fluid-power media, including fire-resistant hydraulic fluids, will burn under certain conditions.

Fluids which escape from pressurized systems may form a mist or fine spray which can flash or explode upon contact with an ignition source.

Consider selecting, guarding, and routing hose to minimize the risk of combustion (ref to Section 5 ISO 3457).

### Fire and explosions from staticelectric discharge

Fluid passing through hose can generate static electricity, resulting in static-electric discharge. This may create sparks that can ignite system fluids or gases in the surrounding atmosphere.



When this potential exists, select hose specifically designed to carry the static-electric charge to ground.

### **Electrical Shock**

Electrocution could occur if hose conducts electricity through a person. Some application could require a non conductive hose in order to avoid electricity (rif. ISO 3949).

Some other require a hose with sufficient conductivity to carry the static-electric charge to ground.

### **Mechanisms controlled by fluid Power**

Mechanisms controlled by fluids in hoses can become hazardous when a hose fails.

- Always install protective shield between operator and mechanical device;
- Do not work next to pressurized equipments;
- Do not touch system under pressure;
- Always use proper safety equipment, including eye protection, breathing apparatus, and adequate ventilation;
- Always appropriately trained staff to the preparation, assembly and use equipments;
- The user should design and implement a maintenance program that suits the specific application and each specific hose in that application.

### **Hose Fittings.**

Selection of the proper hose fittings as well related assembly equipment for the hose and application is essential for proper operation and safe use of hose. Hose fittings are qualified with the hose.

Therefore, select only hose fittings compatible with the hose for the applications.

Improper selection of hose fittings or related assembly equipment for the application can result in injury or damage from leaks, or from hose assemblies blowing apart.

### **Hose-Assembly Fabrication.**

Persons fabricating hose assemblies should be trained in the proper use of equipment and materials. The manufacturers' instructions must be followed.

Properly assembled fittings are vital to the integrity of a hose assembly. Improperly assembled fittings can separate from the hose and may cause serious injury or property damage from whipping hose, or from fire or explosion of vapor expelled from the hose.

### **Hose-Assembly Fabrication.**

Hose fitting components from one manufacturer are not usually compatible with fitting components supplied by another manufacturer. For example, do not use a hose fitting nipple from one manufacturer with a hose socket from another manufacturer.

It is the responsibility of the assembler to consult the manufacturer's written instructions or the manufacturer directly for information on proper fitting components.



**ATTENTION:** IMM advises to use only IMM hose and fittings.

IMM guarantee the stated performances of its products when assembled in accordance to the IMM data sheets and the official swaging parameters.

For any solution different from the suggested, the manufacturer must be contacted.

## Unilock - Assembly Instructions

Cut the hose right angled with a sharp knife. If necessary it is possible to use a lubricant (water/soap solution with 5 % soap fluid and 95 % water) for easy assembly.



Insert fitting into hose until first barb is in hose. Place end of fitting against a flat object (bench, door, wall) and grip hose approximately at 2 centimetres from end and push with a steady force until end of hose is covered by red plastic collar.

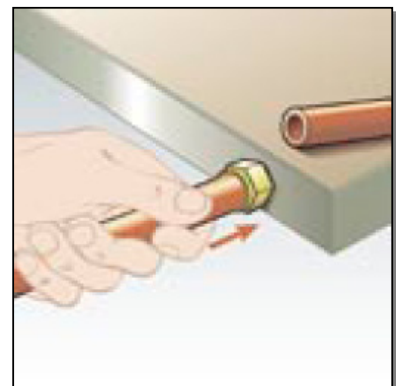

During assembly, please remind that UniLock fittings can be used just after a fully insertion, where the cutted end of the hose is completely concealed by the plastic collar.

## Unilock - Disassembly Instructions

Cut lengthwise along a line around 2 centimetres with a 20° angle from the centre line of hose. Be careful not to nick fitting's barbs when cutting the hose.

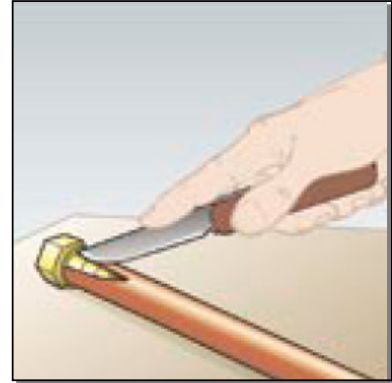

Grip hose and give a sharp down-ward tug to get the fitting free.

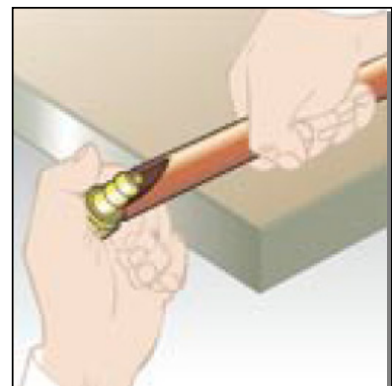

During assembly, please remind that UniLock fittings can be used just after a fully insertion, where the cutted end of the hose is completely concealed by the plastic collar.

## IMM cover solutions

Hose cover is a critical aspect to correctly intercept customer's need and to properly meet application requirements. I.M.M. provide all the solutions for the related applications.

### Abrasion Resistant Cover Options



Standard cover



Extra & MSHA cover



Mega cover

#### Standard cover

Competitive and reliable solution for the general hydraulic application.

The IMM Standard cover ensure performance higher than the standard products of the competitors and the standard market requests ensuring reliability and long life expectation in field.

#### Extra & MSHA cover

The Extra Cover is designed and developed for very demanding applications.

The extreme values of abrasion and ozone resistance permit to use it with profitability in the presence of:

- continuous flexing even with small bend radius combined with high abrasion: forklift masts and telescopic arms;
- direct exposure to sunlight: the hydraulic line smounted out of the machine body;
- the hose bundles subject to flexing and different pressure levels: hoses to connect the excavator arms;
- the hoses exposed to hose-to-metal abrasion and to impact with external bodies.

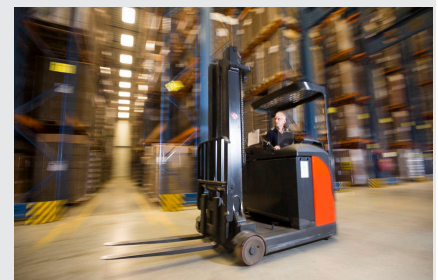

The MSHA cover is the right answer for mining application but not only. Moving the performance of abrasion and ozone resistance at the limit permitted to the rubber compound is able to extend the life expectation of the products in the very tough environments.



### Low temperature cover

The special mix of polymers and additives makes this rubber able to work with external temperature up to  $-50^{\circ}\text{C}$  being a reliable solution even in extreme conditions.

### High temperature cover

Special solution for hoses exposed to ambient temperature over  $100^{\circ}\text{C}$ . The HT cover is recommended for:

- application in engine compartment of truck e.g. power steering application
- injection moulding for the heating circuits
- foundry

The special compound used to withstand high temperature is not recommended in case of high ozone concentration and/or sunlight exposure. In the foundry the HT cover doesn't replace the fiber glass end/or silicon protection sleeve



## Mega cover

Composit solution with external layer in UHMWPE, it is the best solution against hose abrasion and aggressive environments.

This cover allows to eliminate the hose-to-hose and the hose-to-external body abrasion.

In several cases this solution allows to replace an external hose protection as PU sleeve, thermoplastic or steel wire springs with high cost saving.

The good chemical stability, the ozone and UV resistance and the water resistance make this cover a good choice also in case of heavy working ambient, such as subsea application, in-oil application, snow gun application.

The MEGA cover is now MSHA approved.



## IMM cover key features

Abrasion Resistance according to ISO 6945 (F= 25N – 2000 cycles):

- Usual Standard Requirement: max 0,50 g lost
- IMM Standard cover: 0,10 g lost
- IMM Extra cover: 0,01g lost
- IMM MSHA cover: 0,005g lost
- IMM Mega cover: 0,0000g

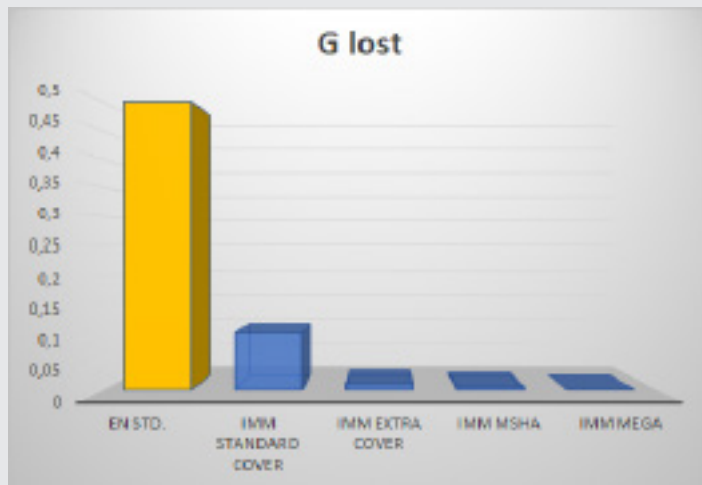

Ozone Resistance according to ISO 7326 (50 pphm – T=40°)

- Usual Standard Requirement: min. 70h
- IMM Standard cover: 400h
- IMM Extra cover: 720h
- IMM MSHA cover: higher than 800h
- IMM Mega cover: higher than 1000h

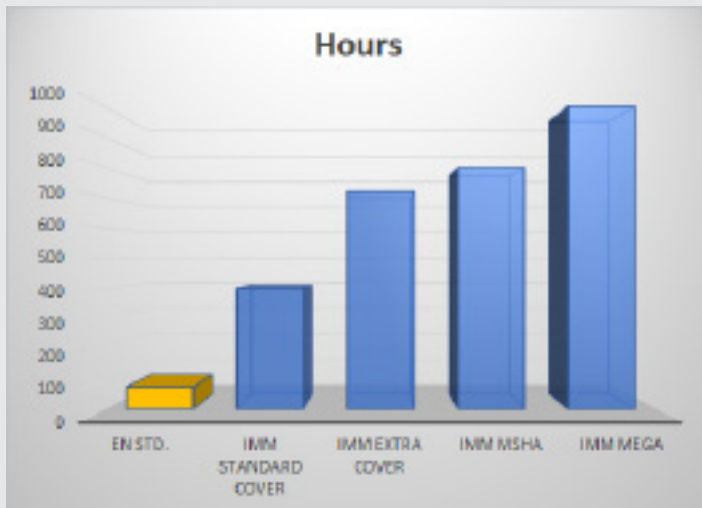



## Thread Diameter

Type	thread	dash	male (mm)		female (mm)	
			size	max	min	max
BSP	1/8-28	02	9,7	9,5	8,8	8,6
Metric	M10x1	10	9,9	9,8	9,1	8,9
UNF	7/16-20	04	11,0	10,9	10,0	9,7
Metric	M12x1,5	12	11,9	11,7	10,6	10,4
UNF	1/2-20	05	12,6	12,5	11,6	11,3
BSP	1/4-19	04	13,1	12,9	11,8	11,4
Metric	M14x1,5	14	13,9	13,7	12,6	12,4
UNF	9/16-18	06	14,2	14,0	13,0	12,8
UNF	5/8-18	07	15,8	15,6	14,6	14,4
Metric	M16x1,5	16	15,9	15,7	14,6	14,4
BSP	3/8-19	06	16,6	16,4	15,3	15,0
UN	11/16-16	09	17,4	17,2	16,1	15,7
Metric	M18x1,5	18	17,9	17,7	16,6	16,4
UNF	3/4-16	08	19,0	18,8	17,6	17,3
Metric	M20x1,5	20	19,9	19,7	18,6	18,4
UN	13/16-16	11	20,5	20,4	19,2	18,9
BSP	1/2-14	08	20,9	20,7	19,1	18,6
Metric	M22x1,5	22	21,9	21,7	20,6	20,4
UNF	7/8-14	10	22,1	21,9	20,6	20,3
BSP	5/8-14	10	22,9	22,6	21,1	20,6
UNS	1-14	13	25,3	25,1	23,8	23,4
Metric	M26x1,5	26	25,9	25,7	24,6	24,4
BSP	3/4-14	12	26,4	26,2	24,6	24,1
UN	1.1/16-12	12	26,9	26,7	25,1	24,7
Metric	M30x1,5	30	29,9	29,7	28,6	28,4
Metric	M30x2	30	29,9	29,7	28,2	27,8
UN	1.3/16-12	14	30,1	29,8	28,3	27,9
UN	1.5/16-12	16	33,2	33,0	31,4	31,0
BSP	1-11	16	33,2	32,9	30,9	30,3
Metric	M36x2	36	35,9	35,7	34,2	33,8
UN	1.7/16-12	15	36,4	36,2	34,6	34,2
Metric	M38x1,5	38	37,9	37,7	36,6	36,4
UN	1.5/8-12	20	41,2	40,9	39,4	39,0
BSP	1.1/4-11	20	41,9	41,6	39,5	39,0
Metric	M42x2	42	41,9	41,7	40,2	39,8
UN	1.11/16-12	21	42,8	42,5	41,0	40,6
Metric	M45x1,5	45	44,9	44,7	43,6	43,4
Metric	M45x2	45	44,9	44,7	43,2	42,8
UN	1.7/8-12	24	47,5	47,3	48,7	45,3
BSP	1.1/2-11	24	47,8	47,4	45,4	44,8
UN	2-12	32	50,7	50,5	48,9	48,5
Metric	M52x2	52	51,9	51,7	50,2	49,8
BSP	2-11	32	59,6	59,3	57,2	56,7
UN	2.1/2-12	32	63,4	63,2	61,6	61,2

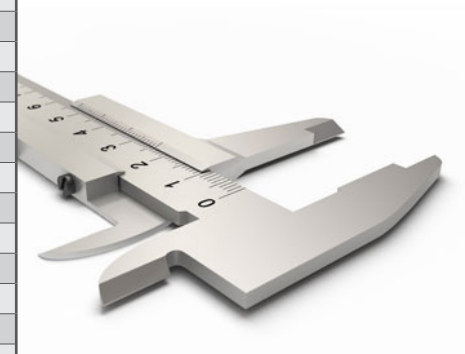

## Manufacturing Standards

Description	Standards
BSP	BS 5200 ; ISO 8434-6 ; ISO 12151-6
Metric 24°	DIN 3861; DIN 3865 ; ISO 8434-1 ; ISO 8434-4 ; ISO12151-2
Metric 60°	DIN 7631; DIN 3863
ORFS	SAE J1453 ; ISO 8434-3 ; ISO12151-1
NPT	SAE J514
Jic 37°	SAE J514 ; ISO 8434-2 ; ISO 12151-5
SAE Flange 3000 Series	SAE J518 ; ISO 6162-1 ; ISO 12151-3
SAE Flange 6000 Series	SAE J518 ; ISO 6162-2 ; ISO 15151-3
Banjós	DIN 7642
JIS	JIS B 8363

## Recommended installation torque

BSPP		with O-RING		without O-RING	
inch	dash size	Nm	Lb.ft	Nm	Lb.ft
1/8	02	15	11	20	15
1/4	04	20	15	25	18
3/8	06	27	20	34	25
1/2	08	47	35	59	44
5/8	10	56	41	85	63
3/4	12	80	59	118	87
1	16	109	80	137	101
1 1/4	20	133	98	167	123
1 1/2	24	164	121	206	152
2	32	196	145	245	181

Metric		dash	Nm	Lb.ft
mm	size			
M12-1.5	12	23	17	
M14-1.5	14	26	19	
M16-1.5	16	30	22	
M18-1.5	18	41	30	
M20-1.5	20	53	39	
M22-1.5	22	76	56	
M24-1.5	24	88	65	
M26-1.5	26	106	78	
M30-2	30	116	86	
M36-2	36	133	98	
M42-2	42	151	111	
M45-2	45	173	128	
M52-2	52	202	149	

JIC 74°		Nm	Nm	Lb.ft	Lb.ft
inch	dash size	min	max	min	max
7/16	04	15	17	11	13
1/2	05	19	22	14	16
9/16	06	27	30	20	22
5/8	07	40	45	30	33
3/4	08	59	65	44	48
7/8	10	68	79	50	58
1 1/16	12	107	119	79	88
1 3/16	14	128	140	94	103
1 5/16	16	158	170	117	125
1 5/8	20	215	237	159	175
1 7/8	24	254	288	187	212
2 1/2	32	339	384	250	283

JIS 60°		dash	Nm	Lb.ft
inch	size			
1/4	04	25	18	
3/8	06	34	25	
1/2	08	59	44	
5/8	10	85	63	
3/4	12	118	87	
1	16	137	101	
1 1/4	20	167	123	
1 1/2	24	206	152	
2	32	245	181	

SAE J518		Code 61 Flange Half Bolt			
inch	dash size	Nm min	Nm max	Lb.ft min	Lb.ft max
1/2	08	15	19	11	14
3/4	12	21	29	15	21
1	16	27	35	20	26
1 1/4	20	35	46	26	34
1 1/2	24	46	58	34	43
2	32	54	66	40	49
2 1/2	40	79	91	58	67

ORFS		dash	Nm	Lb.ft
inch	size			
9/16	06	25	18	
11/16	09	38	28	
13/16	11	57	42	
1	13	90	66	
1 3/16	14	130	96	
1 7/16	15	170	125	
1 11/16	21	200	148	
2 1/2	32	240	177	

SAE J518		Code 62 Flange Half Bolt			
inch	dash size	Nm min	Nm max	Lb.ft min	Lb.ft max
1/2	08	15	19	11	14
3/4	12	25	33	18	24
1	16	42	50	31	37
1 1/4	20	62	75	46	55
1 1/2	24	116	133	86	98
2	32	199	216	147	159

SAE Seal-Lok		dash	Nm	Lb.ft
inch	size			
1/4	04	10	12	
3/8	06	18	20	
1/2	08	32	35	
5/8	10	46	50	
3/4	12	65	70	
1	16	92	100	
1 1/4	20	125	140	
1 1/2	24	130	165	

## Conversion Unit

unit	from	to	coeff.
length	m meters	ft foot	3.281
length	mm millimeters	n inch	0.03934
area	m <sup>2</sup> square meter	in <sup>2</sup> square inch	1550
volume	l liters	gal gallon (UK)	0.264
mass	kg kilogramme	lb pound	2.205
torque	N·m newton/meters	lb/ft pound/foot	0.7374
speed	m/s meters/second	ft/s feet per second	3.281
flow rate	l/min liters per minute	gal/min gallon per minute	0.264
pressure	bar (105N/m <sup>2</sup> )	psi pound/square inch	14.503
temperature	°C celsius	°F fahrenheit	°C(9/5)+32

## Pressure conversion factors

METRIC TO PSI			
1 kPa = 0.145 psi			
bar	Mpa	kPa	psi
40	4	4000	580
50	5	5000	725
60	6	6000	870
70	7	7000	1015
80	8	8000	1160
90	9	9000	1305
100	10	10000	1450
200	20	20000	2900
300	30	30000	4350
400	40	40000	5800
500	50	50000	7250
600	60	60000	8700
700	70	70000	10150
800	80	80000	11600
900	90	90000	13050
1000	100	100000	14500
2000	200	200000	29000
3000	300	300000	43500

PSI TO METRIC			
1 psi = 6.89 kPa			
psi	kPa	Mpa	bar
500	3445	3,4	34
600	4134	4,1	41
700	4823	4,8	48
800	5512	5,5	55
900	6201	6,2	62
1000	6890	6,9	69
2000	13780	13,8	138
3000	20670	20,7	207
4000	27560	27,6	276
5000	34450	34,5	345
6000	41340	41,3	413
7000	48230	48,2	482
8000	55120	55,1	551
9000	62010	62,0	620
10000	68900	68,9	689
20000	137800	137,8	1378
30000	206700	206,7	2067
40000	275600	275,6	2756

## Thread Codes

	BSP	Metric		Jic SAE / UN UNF	ORFS UN UNF UNS	NPTF
02	1/8"-28					1/8"-27
04	1/4"-19			7/16"-20		1/4"-18
05				1/2"-20		
06	3/8"-19			9/16"-18	9/16"-18	3/8"-18
07				5/8"-18		
08	1/2"-14			3/4"-16		1/2"-14
09					11/16"-16	
10	5/8"-14	M10x1	M10x1,5	7/8"-14		
11					13/16"-16	
12	3/4"-14	M12x1.5		1.1/16"-12		3/4"-14
13					1"-14	
14		M14x1.5		1.3/16"-12	1.3/16"-12	
15					1.7/16"-12	
16	1"-11	M16x1.5		1.5/16"-12		1"-11.1/2
18		M18x1.5				
20	1.1/4"-11	M20x1.5		1.5/8"-12		1.1/4"-11.1/2
21					1.11/16"-12	
22		M22x1.5				
24	1.1/2"-11	M24x1.5		1.7/8"-12		1.1/2"-11.1/2
26		M26x1.5				
30		M30x1.5	M30x2			
32	2"-11			2.1/2"-12	2"-12	2"-11.1/2
36		M36x1.5	M36x2			
38		M38x1.5				
40	2.1/2"-11					
42		M42x2				
45		M45x1.5	M45x2			
52		M52x1.5	M52x2			

SAE	ISO ref		R5	
	mm	inches	mm	inches
-2	3,2	1/8	-	-
-3	5	3/16	-	-
-4	6,4	1/4	4,8	3/16
-5	8	5/16	6,4	1/4
-6	10	3/8	7,9	5/16
-	-	13/32	-	-
-8	12,5	1/2	10,3	13/32
-10	16	5/8	12,7	1/2
-12	19	3/4	15,9	5/8
-14	-	7/8	-	-
-16	25	1	22,2	7/8
-	-	1,1/8	-	-
-20	31,5	1,1/4	28,6	1,1/8
-	-	1,3/8	-	-
-24	38	1,1/2	34,9	1,3/8
-	-	1,13/16	-	-
-32	51	2	46	1,3/16
-36	-	2,1/4	-	-
-40	64	2,1/2	60,3	2,3/8
-48	76	3	-	-
-56	89	3,1/2	-	-
-64	102	4	-	-

## ID hose size identification

## Chemical resistance table

Resistance \ Chemical name	NBR	CR	NBR/PVC	PTFE
Petroleum based oil	1	3	2	1
Diesel fuel	1	2	2	1
Water glycol emulsions	1	1	1	1
Phosphate esters	5	4	4	1
Gas permeation	3	3	3	3
Weathering	5	2	2	1
Ozone	3	1	2	1
Heat	3	3	3	1
Low temperature	4	3	3	3
Flame resistance	5	1	2	1
Bio oil	1	5	4	1

### Legend:

1- Excellent      2- Very      3- Good      4- Sufficient      5- Poor

These values are for guidance only and they are related to the hose liner. Several factors in working operations could affect hose service life. For details concerning specific fluid, contact IMM Technical department. The outer cover of the hose is intended to protect the reinforcement layer(s) from mechanical influences (abrasion, weathering, etc), cover compounds are not designed to exhibit the same chemical resistance as the tube compounds. I.M.M. Hydraulics should be consulted about the compatibility of the cover, should the application involve the extended exposure or immersion in a liquid: anyway the hydraulic hoses of the IMM product range are not designed in general for immersion in the service fluid. This type of special applications should be avoided or carefully studied with additional external protections for the hoses, selection of special hose types, e.g. with thermoplastic cover and validation on the specific application. The turbulence of the fluid, the high temperature and nature of the fluid as well as other elements may impact the properties or integrity of the hose cover material (the cover compound of the hose is designed to resist to oil drops and external agents, not immersion in the service fluid). For more detailed information contact I.M.M. Hydraulics.

### Polymer based compound:

<b>NBR</b>	TFD2012-TFD2022-TFE201K-TFE202K-TFA201KI-TFA202KI-TFS0017-TSR04SP-TFS0006I-TFE02TEI-TFE03TEI-TFS0004-TFS0005-TFDH011-TFDH021-TFDL011-TFDL021-TFE2P15-TFE2PF2-THE201K-TFE202K-THE0T3K-THE2M2K-TFDG4SH-TFDG013-TFDG015-TIS0021-TIS0028-TIS0035-TIS0042-THL201K-THL202K-T2E101K-T2E102K-TFDE011-THE2J2K-TTRK200-TTRK300-TTRK300-THEMMDR-THS00JG-THE0G1K-TSG0042-THD0500-TFN201K-TFB201K-TFN202K-TFB202K-TFW0070-TFW0085-TFW0110-TFW0125-TFW0145
<b>CR</b>	TFDM4SP
<b>EPDM</b>	TEB0E28-TEN0E28-TEB0E42-TEN0E42-TCB0E28-TCN0E28-TCB0E42-TCN0E42
<b>POLYESTER</b>	TFS0007-TFS0008-TFS00H1-TFS00H2-TFS00HP-TFS0018-TFS00MP-TFS00CP
<b>P.T.E.</b>	TF000T1-TF00LTC



REFERENCE STANDARD	Max Working Pressure of main connections (design factor 4:1)							
	CONNECTION							
ISO 8434-6		Thread Size	1/8	1/4		3/8	1/2	5/8
	BSP 60° cone with o-ring	MAX WP		400		400	350	350
	BSP 60° cone without o-ring	MAX WP	350	350		350	315	315
ISO 8434-2	37° flared (JIC)	Thread size		7/16-20	1/2-20	9/16-18	3/4-16	7/8-14
		MAX WP		350	350	350	310	240
ISO 8434-3	O-ring face seal (ORFS)	Thread size		9/16-18	5/8-18	11/16-16	13/16-16	1-14
		MAX WP		630	630	630	630	400
ISO 8434-1	24° cone light series	Thread size	M12X1.5 (6L)	M14X1.5 (8L)	M16X1.5 (10L)	M18X1.5 (12L)	M22X1.5 (15L)	M26X1.5 (18L)
		MAX WP	415	400	350	330	275	250
	24° cone heavy series	Thread size	M16X1.5(8S)	M18X1.5 (10S)	M20X1.5 (12S)	M22X1.5 (14S)	M24X1.5 (16S)	M30X2 (20S)
		MAX WP	630	630	630	630	420	420
SAE J518 ISO 6162-1 ISO 6162-2		Flange size					1/2	
	Flanged 3000 PSI (Code 61)	MAX WP					350	
	Flanged 6000 PSI (Code 62)	MAX WP					420	
SAE J514	NPTF (dry seal pipe)	Thread size	1/8	1/4		3/8	1/2	5/8
		MAX WP	345	275		275	240	
JIS B 8363	BSP 60° inverted cone (Toyota)	Thread size		1/4		3/8	1/2	5/8
		MAX WP		345		345	345	275
	BSP 60° inverted cone (Komatsu)	Thread size		M14X1.5	M16X1.5	M18X1.5	M22X1.5	M24X1.5
		MAX WP		345	345	345	345	280

REFERENCE STANDARD	Max Working Pressure of main connections (design factor 4:1)							
	CONNECTION							
ISO 8434-6		Thread Size	3/4	1	1.1/4	1.1/2	2	
	BSP 60° cone with o-ring	MAX WP	315	250	200	160	125	
	BSP 60° cone without o-ring	MAX WP	250	200	160	125	80	
ISO 8434-2	37° flared (JIC)	Thread size	1.1/16-12	1.5/16-12	1.5/8-12	1.7/8-12	2-1/2-12	
		MAX WP	240	210	170	140	105	
ISO 8434-3	O-ring face seal (ORFS)	Thread size	1.3/16-12	1.7/16-12	1.11/16-12	2-12		
		MAX WP	400	400	250	250		
ISO 8434-1	24° cone light series	Thread size	M30X2 (22L)	M36X2 (28L)	M45X2 (35L)	M52X2 (42L)		
		MAX WP	215	165	125	100		
	24° cone heavy series	Thread size	M36X2 (25S)	M42X2 (30S)	M52X2 (38S)			
		MAX WP	420	420	420			
SAE J518 ISO 6162-1 ISO 6162-2		Flange size	3/4	1	1.1/4	1.1/2	2	
	Flanged 3000 PSI (Code 61)	MAX WP	350	350	280	210	210	
	Flanged 6000 PSI (Code 62)	MAX WP	420	420	420	420	420	
SAE J514	NPTF (dry seal pipe)	Thread size	3/4	1	1.1/4	1.1/2	2	
		MAX WP	210	170	150	140	140	
JIS B 8363	BSP 60° inverted cone (Toyota)	Thread size	3/4	1	1.1/4	1.1/2		
		MAX WP	275	205	170	105		
	BSP 60° inverted cone (Komatsu)	Thread size	M30x1.5	M33X1.5	M36X1.5	M42X1.5		
		MAX WP	280	205	170	105		

HOSE CHART

HOSE REFERENCE		Size	03	04	05	06	08	10	12	16	20	24	32	40	48	COVER	HOSE OPERATING TEMP	
		DN	5	6	8	10	12	16	19	25	31	38	51	63	78			
Hose	Code	Reference Standard	MAX WORKING PRESSURE [bar]													ABRASION RESISTANCE LEVEL	Temp Range [°C]	
International Standard	Hypress OneSN	TFD2012	EN 853-SAE 100R1AT- ISO 1436	250	225	215	180	160	130	105	88	63	50	40				
	Hypress TwoSN	TFD2022	EN 853-SAE 100R2AT- ISO 1436	415	400	350	330	275	250	215	165	125	90	80			I	-40 ÷ 100
	Hypress 1SC	TFE201K	EN 857-ISO 11237		225	215	180	160	130	105	88						I	-40 ÷ 120
	Hypress 2SC	TFE202K	EN 857-SAE 100R16-ISO 11237		400	350	330	275	250	215	165						I	-40 ÷ 120
	EASY K 1SC	TFA201KI	EN 857-ISO 11237		225	215	180	160	130	105	88						I	-40 ÷ 100
	EASY K 2SC	TFA202KI	EN 857-ISO 11237		400	350	330	275	250	215	165						I	-40 ÷ 100
	Hypress R17	TFS0017	ISO 11237-SAE 10017	210	210	210	210	210	210	210	210						I	-40 ÷ 100
	Hypress FourSP	TSR04SP	IMM - Exceeding EN 856				445	415	350	350	280	210	185				I	-40 ÷ 100
	Hypress 4SP	TFDM4SP	EN 856-ISO 3862		450		445	415	350	350	280	210	185	165			I	-40 ÷ 100
	Unilock	TFS0006	SAE 100R6 - EN 854	34	28	28	28	28	24	280	20						I	-40 ÷ 100
	Hypress 2TE	TFD02TE	EN 854	80	75	68	63	58	50	45	40	35					I	-40 ÷ 100
	Hypress 3TE	TFD03TE	EN 854	160	145	130	110	93	80	70	55	45	40	33			I	-40 ÷ 100
	Hy-VACUUM	TFS0004	SAE 100 R4							21	17	14	11	7	4	4	I	-40 ÷ 100
	SAE 100R5	TFS0005	SAE 100R5		210	210	157	140	122	105	56	43	35	24			I	-40 ÷ 100
High performance	HyCelsius 1SN	TFDH011B	EN 853-SAE 100R1AT- ISO 1436		225	215	180	160	130	105	88	63	50	40	30	I	-40 ÷ 135	
	HyCelsius 2SN	TFDH021B	EN 853-SAE 100R2AT- ISO 1436		400	350	330	275	250	215	165	125	90	80		I	-40 ÷ 135	
	HyFreeze 1SN	TFDL011	EN 853-SAE 100R1AT- ISO 1436		225	215	180	160	130	105	88	63	50	40		I	-50 ÷ 100	
	HyFreeze 2SN	TFDL021	EN 853-SAE 100R2AT- ISO 1436		400	350	330	275	250	215	165	125	90	80		I	-50 ÷ 100	
	Pilot Plus 150	TFE2P15	IMM Specs	150	150	150	150	150								I	-40 ÷ 120	
	Pilot Flex 120	TFE2PF2	IMM Specs	120	120	120										II	-40 ÷ 100	
	LongLife 1SC	THE201K	EN 857-ISO 11237		250	250	250	200	150	150	110	100	90	75	50	40	II	-40 ÷ 120
	LongLife 2SC	THE202K	EN 857-SAE 100R16-ISO 11237		430	400	350	310	280	240	210	160	150	100	80	65	II	-40 ÷ 120
	TREEATHLON	THE0T3K	IMM Specs				500	475	420	380	315						II	-40 / 100
	Marathon	THE0M2K	EN 857-SAE 100R16-ISO 11237		450	420	385	350	350	280	250						II	-40 ÷ 120
	HyGreen 4SH	TFDG4SH	EN 856-ISO 3862							420	385	350	300	250			II	-40 ÷ 120
	HyGreen R13	TFDG013	SAE 100R13-ISO 3862							350	350	350	350	350			II	-40 ÷ 121
	HyGreen R15	TFDG015	SAE 100R15-ISO 3862						420	420	420	420	420	420			II	-40 ÷ 121
	Isobaric	HySO-FLEX 3K WB	TIB0021	ISO 18752		210	210	210	210	210	210						II	-40 ÷ 120
HySO-FLEX 4K WB		TIB0028	ISO 18752		280	280	280	280	280	280						II	-40 ÷ 120	
HySO-FLEX 5K WB		TIB0035	ISO 18752		350	350	350									II	-40 ÷ 120	
HySO-FLEX 6K WB		TIB0042	ISO 18752		420											II	-40 ÷ 120	
HySO-FLEX 3K WS		TIS0021	ISO 18752									210	210	210		II	-40 ÷ 120	
HySO-FLEX 4K WS		TIS0028	ISO 18752				280	280	280	280	280	280	280			II	-40 ÷ 120	
HySO-FLEX 5K WS		TIS0035	ISO 18752				350	350	350	350	350	350	350			II	-40 ÷ 120	
HySO-FLEX 6K WS		TIS0042	ISO 18752				420	420	420	420	420	420	420			II	-40 ÷ 120	

HOSE CHART

HOSE REFERENCE		Size	03	04	05	06	08	10	12	16	20	24	32	40	48	COVER	HOSE OPERATING TEMP
		DN	5	6	8	10	12	16	19	25	31	38	51	63	78		
Hose	Code	Reference Standard	MAX WORKING PRESSURE [bar]													ABRASION RESISTANCE LEVEL	Temp Range [°C]
COMPRESSOR 1SN	TFDC011B	EN 853-SAE 100R1AT-ISO 1436		225	215	180	160	130	105	88	63	50	40				
LongLift 1SC	THL201K	EN 857 - ISO 11237		250	250	250	200	150	150	110						II	-40 ÷ 120
LongLift 2SC	THL202K	EN 857 - SAE 100R16 - ISO 11237		430	400	350	310	280	240	210						II	-40 ÷ 120
LongLife Dual 1SC	T2E101K	EN 857 - ISO 11237		250	250	250	200									II	-40 ÷ 120
LongLife Dual 2SC	T2E102K	EN 857 - SAE 100R16 - ISO 11237		430	400	350	310									II	-40 ÷ 120
Railway	TFDE011	EN 853 - SAE 100R1AT - ISO 1436		225	215	180	160	130	105	88							-40 ÷ 100
HyJack	THE2J2K	IMM Specs		760		725										II	-40 ÷ 100
Hytruck 200	TTRK200	IMM Specs							200	200						I	-40 ÷ 100
Hytruck 250	TTRK250	IMM Specs							250	250						I	-40 ÷ 100
Hytruck 350	TTRK300	IMM Specs							350	350						I	-40 ÷ 100
MegaDrill	THEMMDR	ISO 3862 R13 - IMM SPEC.							350	"350 210"						II	-40 ÷ 100
MegaJet	THS00JG	IMM Specs								600	550	500	480			II	-40 ÷ 100
HyGEAR 1SC	THE0G1K	EN 857 - ISO 11237							105	88	82	82	68	35		II	-40 ÷ 100
HyTRAKTION	TSG0042	SAE 100 R15 - IMM SPEC.									420	420				II	-40 ÷ 121
HySpir 500	THD0500	IMM SPEC. - Exceed SAE 100 R15							500	500						II	-40 ÷ 100
Hypress Jet 1SC	"TFN001K TFB001K"	IMM Specs - ISO 7751		250	250	250	250									I	-40 ÷ 135
Hypress Jet 2SC	"TFN002K TFB002K"	IMM Specs - ISO 7751		400	400	400	400									I	-40 ÷ 135
HyWASHER 4K	"TEB0E28 TEN0E28"	IMM Specs - ISO 7751		280	280	280	280										+155 /+163
HyWASHER 6K	"TEB0E42 TEN0E42"	IMM Specs - ISO 7751		420	420	420	420										+155 /+163
HyWASHER PLUS 4K	"TCB0E28 TCN0E28"	IMM Specs - ISO 7751		280	280	280	280										+155 /+163
HyWASHER PLUS 6K	"TCB0E42 TCN0E42"	IMM Specs - ISO 7751		420	420	420	420										+155 /+163
Hyblast 10k	TFW0070	IMM Specs - ISO 7751								700						II	-10 ÷ 70
Hyblast 12k	TFW0085	IMM Specs - ISO 7751		850		850	850		850	850						II	-10 ÷ 70
Hyblast 15k	TFW0110	IMM Specs - ISO 7751		1100		1100	1100		1000							II	-10 ÷ 70
Hyblast 18k	TFW0125	IMM Specs - ISO 7751				1250	1200									II	-10 ÷ 70
Hyblast 20k	TFW0145	IMM Specs - ISO 7751				1450	1450		1350							II	-10 ÷ 70
Hypress R7	TFS0007	SAE 100R7 - ISO 3949 R7	210	210	190	160	140	105	90	70							-40 ÷ 100
Hypress R8	TFS0008	SAE 100R8 - ISO 3949 R8	350	350	300	280	245	200	165	140							-40 ÷ 100
TP One Steel Braid	TFS00H1		350	310	250	225	190	140	115	95							-40 ÷ 100
TP Two Steel Braid	TFS00H2			400		330	260	220	150								-40 ÷ 100
HyUltra	TFS00HP			700		700											-40 ÷ 100
R18 Low Temp	TFS0018	SAE 100R18	210	210	210	210											-55 ÷ 100
Mini-Flexible	TFS00MP	"Size [inch] WP [bar]"	5/6 4 630	1/8 630	5/3 2 630												-40 ÷ 100
TFS00CP	TFS00CP	Exceeds SAE 100R18	250	250	250	250											-55 ÷ 100
P.T.F.E. T1	TF000T1	WP according to SAE 100R14	200	175	150	135	120	100	90	65							-70 ÷ 260
P.T.F.E. LTC	TF00LTC					125	110	80	70	50	34	30	23				-70 ÷ 260

Solution for applications

Thermoplastic & PTFE

1-Refer to dedicated section for extended Temperature Range information | 2-UNMWPE cover available as alternative (MEGA COVER)

3-Ask technical office for cover different configuration request



# General sales terms and conditions

## GENERAL SALES TERMS AND CONDITIONS

These General Terms of Sale are an integral part of all our material supply contracts also when we take orders by telephone, orally, by fax, mail or internet.

In case of direct sale to Customer (natural person who works for reasons not referring to professional activity eventually performed) the relation between I.M.M. Hydraulics and its customer will be disciplined by regulations on customer protection, legislative decree, n. 206 on 6 September 2005.

### General terms

Sales conditions and delivery terms are those stated in offers and/or order acknowledgment.

Any different condition from those is not valid unless written confirmation.

All the information referring to the drawings, catalogues, dimensions or more are not binding and can be changed in any moment without notice.

Any different and specific condition and every order of customized item can/shall be subjected to a different and separated agreement. In case of conflict between these standard conditions and any other special condition agreed between the parties, special condition shall apply, except all other general conditions, which details are set forth hereinafter, where applicable.

### 1 - Orders

All the orders must be sent by mail or by fax to the addresses listed on websites:

[www.interpumpfluidsolutions.com](http://www.interpumpfluidsolutions.com) and/or to the e-mailbox "Orders" [orders@imm-hydraulics.it](mailto:orders@imm-hydraulics.it)

Any telephone order must be confirmed in writing. All the orders have to clearly report the I.M.M. Hydraulics catalogue part/numbers and the delivery instructions.

Each order has to be confirmed in writing by I.M.M. Hydraulics (Order acknowledgment). Any disagreement between Customer order and I.M.M. Hydraulics acknowledgment must be immediately notified (within six working days after acknowledgment receipt) by the Customer.

Any cancellation, reduction and/or amendments on order already acknowledged by I.M.M. can be made within 5 days from order date by emailing or faxing to vendor.

Any cancellation of item on drawing and/or customized hose, already manufactured by the Supplier will be however billed and shall be paid.

### 2 – Order quantities

The quantities shown in the order have to be in compliance with the offered pre-packaged quantities (or multiple of them). Therefore the evidence of the quantity per package is not yet shown in the catalogue: for this reason I.M.M. Hydraulics is committed to notify in case of not compliance (using the order acknowledgment form) the right quantity per package.

Stock availability for the above-mentioned items is not guaranteed . Considering specific applications for some items , order acknowledgment can be subject to a minimum quantity equal to a manufacturing batch in force at the time of order.

In case that the Customer requires to I.M.M. Hydraulics the development and production of specific products, the Customer must guarantee the purchase of the whole committed production under the original terms and conditions.

### 3 – Free License

When achieved the sales target agreed between the parties, I.M.M. will grant to the customer the free use of its trademarks within the limits and under the conditions defined below which the licensee hereby accepts.

The use of trademarks is granted exclusively and is restricted to the distribution of the products, with nontransferable license to third parties, without exclusive rights and without the possibility to grant any kind of sub-licenses.

The trademarks may be used only in the business headed directly to the licensee and only as a sign of stores or sales areas of the licensee open to the public, distributing exclusively the products.

The trademarks can also be used on marketing literature to promote the products.

When using the marks on marketing literature, the licensee must play them respecting the example of advertising already used by I.M.M Hydraulics.

It is specified that the marks may not be used:

a) On the products distributed by the licensee;

b) On the internet, except on the Italian website of the licensee. It must be immediately and unmistakably recognizable as a business site exclusively belonging to the licensee and without any possibility to be confused

with other websites using IMM Hydraulics brands.

In case anything is not specified in the present clause, we refer to the attachment "A" of the contract.

The right to use the trademark does not include the right to represent I.M.M. and to act in any way on its behalf in relation to third parties.

Licensee shall provide all the requirements and the necessary precautions to avoid any misunderstanding as to its total independence from I.M.M, whom marks belong to, and to make clear that I.M.M. Hydraulics does not participate in its economic outcomes and it cannot be held liable for losses and debts of the licensee, in any manner, neither for damages caused to third parties by the licensee.

No payment is not due for the license to use trademarks.

The licensee is committed from this very moment to hold harmless I.M.M. from any burden, liabilities, claims that may reach him due to the activity carried out by the licensee using trademarks. The licensee cannot in any manner grant to third parties the use of the trademarks. Any use of trademarks that does not conform to the provisions in the present agreement, shall be previously approved in writing by I.M.M., otherwise it will constitute a serious contract breach and will result in the immediate termination of the contract.

#### **4 – No Competition agreement**

For the duration of the present contract, the customer will not compete with IMM Hydraulics on its or third parties behalf.

#### **5 - Delivery terms**

The concept of date of delivery corresponds to the moment the goods leave I.M.M. Hydraulics stores.

The delivery terms are those shown in order acknowledgment except cases due to causes of "Force majeure". I.M.M. Hydraulics sends goods to customer by a forwarding agent and they shall be interpreted in accordance with the version of INCOTERMS (EXW, FCA, FAS, FOB, CFR, CIF, CPT, CIP, DAT, DAP, DDP) except that cases to establish from time to time and to be detailed in order confirmation.

For returned different from EXW , any other duties connected to transport and/or shipping are calculated in the invoice (according selected Incoterms)

Carriage free shipping is not expected.

Other cases have to be established from time to time and detailed in order confirmation. Once received the goods, the Customer has to verify the package integrity, the exact quantity and the quality according to the delivery note. In case of discrepancy ( missing, opened or damaged packages etc) Customer must notice on delivery note (conditionally acknowledgment) within 48 hours by fax or email to I.M.M. Hydraulics.

Goods will be delivered during all working days. Deliveries will be divided and not for I.M.M. Hydraulics responsibility.

Supposing that ordered articles are not in stock, Customer will be contacted by mail or by telephone to be informed about new delivery time.

Every delay of delivery does not entitle the Customer to cancel or reduce the order, or to penalty payment or indemnity for late delivery unless differently agreed in writing before with I.M.M. Hydraulics.

The company doesn't take any responsibility for any delivery time delay due to the carrier.

#### **6 - Contentions**

Any contentions referring to the material configuration (type of product, quantity, defective packing) has to be communicated within 10 working days from goods delivery. I.M.M. Hydraulics will not accept goods returned if not previously agreed.

#### **7 – The right to withdrawal**

According to art. n. 1456 C.C., in case of breach of commitments by the Customer, see art. 7/8 (price and payment), the Supplier has the right to rescind the contract already closed, by sending a letter with advice of delivery in which he declares to make use of this clause, except any claim for damages. Every variation in capital conditions of the Customer that could put his price payment fulfilment at risk, gives 1461 C.C., the right to cancel deliveries already arranged and rescind the contract in writing, after payment of those services he has already performed to the Customer.

The Supplier is entitled to rescind the contract and not to fulfil delivery commitments every time , because of force majeure or any unpredictable and extraordinary events, delivery shall become too onerous .

The customer will not have right to withdraw from a contract if it refers to:

- Items realized on customer drawing and so customized

As well, the Customer exercises the right to withdraw by e-mail or by fax to the addresses listed on websites: [www.interpumpfluidsolutions.com](http://www.interpumpfluidsolutions.com), according to the above mentioned terms.

That communication must necessarily contain all information as stated below:

- The order number on which withdrawal is exercised;
- Customer expressed will to withdraw fully or part of purchase contract;
- Description and item codes on which withdrawal is exercised;

If these requirements are missing, I.M.M. Hydraulics couldn't legitimize the right to withdraw to the Customer. For business relation propriety, the Customer engages to preserve and take care of received products on which he wants to exercise the right to withdraw, maintaining their integrity and their original package. He engages to return the products not later than 15 days from his expressed will to send them back to the original address. Transport risks and costs for returned goods will totally be on Customer side.

Once received goods according to what above mentioned and after proper checking, the Supplier will pay back the customer as soon as possible.

## 8 - Returns

The following dispositions about returns will be applied in 2 different cases:

- 1) In the error case from I.M.M. Hydraulics during order insertion, dispatch or delivery;
- 2) Supposing I.M.M. Hydraulics decides to its our personal discretion or it agrees with client on application of a regulation in favour of client.

Eventually claims can be accepted on if notified by post, fax or mail in 8 days from the date of material receiving after this period every recess right declines.

After check and acceptance of the returns from the I.M.M., the the goods are made:

- EXW, I.M.M. will take care to send an own carrier for the withdrawal. ( It will be care of the client to anticipate the documents with which the material is received for allowing the opening of the procedure of export in order to recover the non conforming materiel; The customs needs of bill of entry and the MRN number to accept a return from countries outside the EEC);
- DDP IMM warehouse ( any refund for the shipping).

All returned merchandise is subject to quality control to verify compliance with the statements (type, quantity, etc.,) integrity and effectiveness, any reason for return.

If the claim results unfounded, the buyer will be held to compensate to the vendor for all the expenses supported for the assessment (trips, damages, ecc).

## 9 - Price

The prices are considered EXCLUDED VAT and expressed in euro. The prices are related to the actual price-list except different agreements with the Customer.

Any clerical error of calculation and/or updating of order acknowledgment and/or invoice can be corrected in every moment.

All prices included in the price-list are intended "ex works" and "packing included". All prices are supplied in reserve of any trashing errors.

The seller has the right to revise prices of products according to the dynamics of prices of raw materials, labor costs, packaging. The seller must notify the buyer of the new prices within 30 days prior to their application, unless other terms are made by supplier of raw materials.

## 10 - Payments

Payment must be made within the terms and conditions agreed with the I.M.M. and the client.

According to the Law UE 2000/35 and Law 09.10.2002 n.231, in the case of failure to pay, even partial, will be automatically debit default interest with a rate of 7 points higher than that applied by the B.C.E. Interests shall accrue from the day after the due for payment.

In case of protest or of the outstanding securities issued, other expenses will be charged in addition to the default interests referred to above.

Non-payment will void all trade conditions with the client and the suspension of supplies.

Usually, the first supply payment condition is "cash on delivery".

All the payments must be effected exclusively and directly to our addresses.

## 11 - Guarantee

I.M.M. Hydraulics products are secured exempt from defects of material and processing. I.M.M. products are warranted for a period of 12 months from date of purchase.

The warranty is valid only if the buyer complaint defects to the seller within 8 days of discovery through a registered letter, the missed notification within the terms specified, will void the warranty as expressly provided

by the art. 1495 of Italian Civil Code.

The guarantee does not apply to damage caused by negligence, non-conforming use or installation, alterations, any changes including those of the product's identification number, damage caused by accident or negligence of the purchaser. The warranty agreed absorbs legal guarantees for defects and deformities, and includes any other responsibility of IMM, in particular, the buyer shall not make other claims of reparation, cost reduction, or the cancellation of the contract. The maturity of the guarantee no protest may be made against the seller.

The seller cannot be held responsible for any loss of profit, lost production, loss of supply contracts or for any other indirect or consequential damage, but only for damage to persons or property caused by products sold, in case of gross negligence or incompetence in the manufacture of products.

#### **12 - Competent phorum**

Any legal dispute shall be settled by the Court of Lanciano.

#### **13 - Legal interpretation**

Any reference to the general conditions, price lists, or other attachments or other material belonging to the seller or other third parties, should refer to the general conditions and to document signed at the conclusion of the contract.

#### **14 - Privacy**

According to the Law 196/2003, the Client declares to know that his own personal dates are inserted in the I.M.M. Hydraulics Customer Bank Date and they can be used for promotional reasons, commercial and selling and for statistics with consultation, processing or comparison or to send editorial material and/or promotional.

All I.M.M. Hydraulics Customers are invited to read the present general conditions of selling before any orders, because I.M.M. Hydraulics reserve the right to change or update contents in any moment.

Examined the contract, the parties declare to share and accept it in all its parts.

## ATTACHMENT "A"

This document establishes the basic term of the correct methods of application and use of the I.M.M. Hydraulics, Hypress and Interpump Fluid Solutions Powered by I.M.M. Hydraulics brands.

In addition to being a description of the distinctive graphics, it provides all the information concerning the use of the trademark in terms of size, color and possible locations, and also defining its use and misuse.

To request the logo, either in a web or press format one must contact the company directly. Marketing Dept. e-mail address: [marketing@imm-hydraulics.it](mailto:marketing@imm-hydraulics.it).

### USE OF THE LOGO - I.M.M. HYDRAULICS

To maintain the integrity of the logo it is important to consider the following guidelines:

- The logo must be used exclusively with the official colors listed in this manual.
- Any scaling must retain the original proportions of the logo.
- Outside of the variants in this manual, the logo can not be modified in any way.
- No text can be added that may appear to be part of the logo itself.
- Use of the logo is permitted only with prior approval of I.M.M. Hydraulics S.p.A. for the application of the trademark on different types of media articles and services of the brand. In cases of unauthorized use of the trademark, I.M.M. Hydraulics S.p.A. will defend its legal rights in terms of protection of the image and the intellectual property rights .



For the logo, IMM Hydraulics uses the fonts ARIAL BLACK and ARIAL ITALIC.  
For the creation of brochures, catalogs, web media and all communication related to advertising the business, the fonts recommended are: Arial Black - Arial - Century Gotic.

The I.M.M. Hydraulics logo must be used alone, without drawings, pictures or other writing, and it needs space around it to be easily recognizable. The I.M.M. Hydraulics logo has a combination of two pantone shades of dark blue and a slight external shadow. The logo is always presented with these color characteristics, and only in rare exceptions, can it appear in black and white, or gray scale.

### USE OF THE LOGO - HYPRESS

To maintain the integrity of the logo it is important to consider the following guidelines:

- The logo must be used exclusively with the official colors listed in this manual.
- Any scaling must retain the original proportions of the logo.
- Outside of the variants in this manual, the logo can not be modified in any way.
- No text can be added that may appear to be part of the logo itself.
- Use of the logo is permitted only with prior approval of I.M.M. Hydraulics S.p.A. for the application of the trademark on different types of media articles and services of the brand. In cases of unauthorized use of the trademark, I.M.M. Hydraulics S.p.A. will defend its legal rights in terms of protection of the image and the intellectual property rights.



For the logo, Hypress uses the MYRIAD BOLD ITALIC font.  
For the creation of brochures, catalogs, web media and all communication related to advertising the business, the fonts recommended are:  
Arial Black - Arial - Century Gotic - Myriad.

The Hypress logo must be used alone, without drawings, pictures or other writing, and it needs space around it to be easily recognizable. The Hypress logo has a combination of two pantone shades of dark green and a slight external shadow. The logo is always presented with these color characteristics, and only in rare exceptions, can it appear in black and white, or gray scale.

## USE OF THE LOGO - INTERPUMP FLUID SOLUTIONS

To maintain the integrity of the logo it is important to consider the following guidelines:

- The logo must be used exclusively with the official colors listed in this manual.
- Any scaling must retain the original proportions of the logo.
- Outside of the variants in this manual, the logo can not be modified in any way.
- No text can be added that may appear to be part of the logo itself.
- Use of the logo is permitted only with prior approval of I.M.M. Hydraulics S.p.A. for the application of the trademark on different types of media articles and services of the brand. In cases of unauthorized use of the trademark, I.M.M. Hydraulics S.p.A. will defend its legal rights in terms of protection of the image and the intellectual property rights.



**INTERPUMP**  
**FLUID SOLUTIONS** 

For the logo, IMM Hydraulics uses the fonts ARIAL BLACK and ARIAL ITALIC.

For the creation of brochures, catalogs, web media and all communication related to advertising the business, the fonts recommended are: Arial Black - Arial - Century Ghotic.

Powered by **I.M.M. Hydraulics**

The Interpump Fluid Solutions logo must be used alone, without drawings, pictures or other writing, and it needs space around it to be easily recognizable. The logo has a combination of three pantone shades of blue. The logo is always presented with these color characteristics, and only in rare exceptions, can it appear in black and white, or gray scale.



# INTERPUMP

FLUID SOLUTIONS 

Powered by I.M.M. Hydraulics



**I.M.M. Hydraulics Spa**  
[interpumpfluidsolutions.com](http://interpumpfluidsolutions.com)

Via Italia, 49-51  
66041 - Atessa (Ch) - Italy  
T. +39 (0) 0872 889225  
F. +39 (0) 0872 889226



CAT-IFS-G rev. 1.1